

TECHNISCHE UNIVERSITÄT
CHEMNITZ

Fakultät für Informatik

CSR-14-01

**International Summerschool
Computer Science 2014**
**Proceedings of Summerschool
7.7.-13.7.2014**

Juni 2014

Chemnitzer Informatik-Berichte

Inhaltsverzeichnis

“Computer Sign Language Interpreter of Russian Language” <i>Alexey Volyntsev</i>	3
“Harmonic Analyzer Based on PWM Method” <i>Aravenkov Alexander</i>	6
“Mediator in Social Environments” <i>Anke Tallig</i>	12
“Management System for University Topics Based on Homogeneous Object Binding Structure” <i>Daniel Reißner and Wolfram Hardt</i>	16
“VHDL Implementation of Flight Control Functions of Quadcopter and its Integration in Zynq SoC (System on Chip)” <i>Ganzorig Ulziibayar</i>	19
“Analysis Algorithm for Interference Patterns with Random Phase Shifts” <i>Haydukov D.S., Guzhov V.I. and Ilinykh S.P.</i>	23
“Development of Automatic Stabilization System of Two-Wheeled Platform in a Vertical Position” <i>Ivoilov A.Y., Zhmud V.A. and Trubin V.G.</i>	28
“Pro-Active and Socially Capable Pedagogical Agents in Computer- and Web-Based trainings” <i>Madlen Wuttke</i>	34
“Methods of Designing and Modeling of Man-Machine Systems” <i>Mihail G. Grif, Oyunsuren Sundui and Yevgenii B. Tsoy</i>	38
“Case Study of Structure Oriented Evaluation Model” <i>Uranhimeg Tudevdayva, Jargalmaa Dolgor and Bayar-Erdene Lhagvasuren</i>	41
“Object Oriented Medical Technical Expert System” <i>Yumchmaa Ayush and Davaasuren Ravdan</i>	44
“Design of Adaptive Systems for Control of Objects with Changing Parameters and Delay” <i>Yadryshnikov Oleg</i>	47
“Applying the Semantic Analyses of Russian Language in the Computer Sign Language Interpretation System” <i>Yuliya S. Manueva</i>	51
“Localization Methods for a Mobile Robot” <i>Zhanna Pershina and Iurii Sagitov</i>	54

Computer Sign Language Interpreter of Russian Language

A. Volyntsev*

* Novosibirsk State Technical University
Novosibirsk, Russia
alexey.a.volyntsev@gmail.com

Abstract—An approach to creating a computer sign language interpretation system for the Russian language based on comparative analysis of syntactic structures. Describes the software implementation of a computer sign language interpreter used by employees of the Social Rehabilitation Institute at Novosibirsk State Technical University.

Keywords—Russian sign language; computer sign language interpreter; syntax; natural language processing.

I. INTRODUCTION

In any country, a part of the population suffers from hearing loss. A significant number of deaf and hearing-impaired people in the Russian Federation use Russian Sign Language (hereinafter – RSL) in everyday life. There is a physical shortage of sign language interpreters to meet the biolinguistic requirements of deaf people in all areas of their lives: education, healthcare, social services, mobile communications, etc. The gradual replacement of human sign language interpreters with computer sign language interpreters serves the noble task of breaking down barriers that impede communication between deaf and hearing Russian citizens.

In Russia and the rest of the world, a number of computer systems that translate natural language (speech) into manually coded national languages are well known. For example, the hardware and software sign language package at the Novosibirsk State Technical University Institute of Social Rehabilitation. However, the introduction of such software systems into different areas of deaf people's lives is slowed down by the following factors [1-3]:

- 1) The lack of effective software recognition systems for continuous Russian speech.
- 2) Russian text is primarily translated into manually coded language, which makes it difficult for perception by deaf people.
- 3) Absence of a recognised RSL grammatical system.
- 4) Lack of an ergonomic sign language visualisation system.

In this paper, we develop an approach to constructing computerised systems in order to translate from spoken Russian language (hereinafter – SRL) into RSL, including construction of relationships between the grammatical systems

of these languages, analysis of Russian text (speech) and selection of effective strategies for translating into RSL [4].

Development of a computer sign language interpreter for the Russian language relies on earlier linguistic research on RSL regarding its vocabulary, word formation, morphology, syntax and semantics [5].

II. TRANSLATION OF RUSSIAN TEXT INTO RSL

Sign language employs three-dimensional space and is the successive representation (using sign language signs) of static or dynamic situations, which can be characterised as simple or elementary. Situations can be linked, for example, if they involve the same objects.

Sentences in spoken language often describe complex situations that include several simple ones (e.g., several actions). When a human translates from SRL to RSL, such sentences are converted into a sequence of simple sentences, each of which represents one simple situation. Humans carry out these transformations rather well during sign language interpretation, although their formalisation is a very difficult task. Next, we shall consider a class of conversions designed for automatic translation systems from SRL to RSL.

The purpose of the described syntactic and semantic conversions is the simplification of SRL by splitting up sentences presenting complex situations into a sequence of simple sentences. A sentence containing a participle is the unit on which these conversions are performed. A participle denotes an action or condition additional to the one designated by the main verb in the sentence. When each conversion rule is applied, the original sentence is divided into two parts – two sentences, each of which represents fewer situations than the original sentence, and in this sense is a simpler sentence.

During conversion, the original sentence is not simply mechanically separated into two parts, but is also subjected to certain additional modifications. In particular, the participle is replaced with the corresponding verb. Word order can be changed. Pronouns are introduced to identify objects that are referred to.

The developed conversion rules simplify translation from SRL to RSL, but at the same time are not specific to this task and can be used to solve other problems that require a similar simplification of SRL texts.

The development of conversion rules within the scope of a machine translation system was focused on using text analysis results obtained from the parser Dialing. Conversion rules are applied after this analyser builds the structure of the input text and identifies any occurrences of participles. Accordingly, only those sentences with participles that can be identified as such based on the chosen parsing system are subject to changes.

Since the conversion rules are applied after parsing, the categories the analyser utilises to represent the structure of the input sentence are used when describing the rules.

We introduce the following notation for syntactic group types. Participle + Noun – a group of a noun plus a participle-type fragment (participle clause); the noun agrees with the participle in case, number and gender. Adjective + Noun – one or more adjectives that agree in gender, number and case, immediately followed by a noun. Instrumental Object – a group containing an object in the instrumental case. Other groups: Coordinated Noun Phrase, Verb + Adverb, Clause, Prepositional Phrase. One of the syntactic fragment types – participle-type – is also used. When rules are recorded, grammatical categories are identified by the sequences of indicators. When choosing conversion rules, the type of structure in which the participle was found is considered, as well as specific components of this structure. Each type of rules has specific usage conditions.

Before conversion rules are applied to a certain sentence, the occurrence in it of a certain syntactical construction containing a participle is identified. The original sentence is divided into three parts: beginning of sentence, identified syntactical construction, end of sentence. Thus, in the sentence, *The splash of raindrops falling on its surface produced a loud rumble*, the Participle + Noun group corresponds to the part *raindrops falling on its surface*, beginning of sentence – *splash* and end of sentence – *produced a loud rumble*.

The rules can replace or remove some parts of the original text, as well as reorder some parts of it. The following notation is used to describe these operations. A record like $[X (\Psi_1 \rightarrow \Psi_2, \Psi_3 \rightarrow \Psi_4)]$ means that:

1) Ψ_1 are part of $[X]$,

2) in $[X]$, Ψ_1 must be replaced by Ψ_2 , and Ψ_3 by Ψ_4 ,

3) in a sentence resulting from the application of such a conversion, Ψ_2 is in the first position, while all other words remain in the same order as in the original sentence (the sentence may contain words other than those in Ψ_1 and Ψ_2); Ψ_2 occupies the former position of Ψ_1 in X .

General usage condition: rules of this type are applicable only if preceding (morphological and syntactic) analysis identified a Participle + Noun group and a participle.

Each type of rule is represented by several variants (for active and passive participles). As an example, we shall refer to the result of applying one of the rules for converting a sentence with an active participle in which a Noun + Participle group has been identified. The sentence *[The splash of raindrops falling on its surface produced a loud rumble]* will be split into two simpler ones: *[raindrops fell on its surface]* *[the splash of these drops produced a loud rumble]*.

III. SOFTWARE IMPLEMENTATION OF THE CONVERSION RULES

Software implementation of the syntactic transformation of sentences containing participle constructions involves a library that encapsulates the text processing process. As a result of isolating the logic in a .NET code library (.dll assembly), various applications with any user interfaces (console, desktop, web, etc.) can consult the existing library, regardless of language. The library has been developed in C#, but the user interfaces may be created in any language (e.g. VB or C++/CLI). The library contains a single namespace that interacts with components of the Dialing text processing system.

In order to analyse text in natural Russian language, the library makes it possible to:

- Load text and initialise necessary components of the parsing system.
- Divide text into sentences and organise procedures for its conversion.
- Carry out morphological and syntactic analysis of each sentence (building a sentence dependency tree).
- Translate each sentence using syntactic conversion rules (building a sentence translation tree).

We shall now examine the steps of the conversion process, drawing on the example of the complex sentence *We settled down next to the planted shrubs growing on the cut grass*. The result of parsing is a dependency tree, which is stored in the form of an XML document.

The tree structure is arbitrary and is described by a set of nested tags, each of which is either a clause (clause node) and group (group node) built on a morphological variant of the clause, or a syntactic relationship (rel node). A clause is a fragment of a complex sentence, while the internal structure of a group is determined by the type (type attribute).

The syntactic relationship between words is defined by the following attributes:

- name – the type of group.
- gramrel – external grammemes (morphological characteristics) that determine the behaviour and compatibility with other groups.
- lemmprnt – normal form of the main word in the group.
- grmprnt – grammemes of the main word in the group.
- lemmchld – normal form of the dependent word in the group.
- grmchld – grammemes of the dependent word in the group.

The process of converting a sentence involves splitting it up into simpler sentences. A prerequisite to such segmentation is the presence of one or more structures containing a participle. The structures are processed sequentially from left to right. After dividing the original sentence, two simplified sentences are obtained with the corresponding verb instead of the participle that provoked division. A binary tree is used to store data, in which each node stores a sentence, while both its descendants contain the result of division. Fig. 1 shows the binary tree that will be built for the above example:

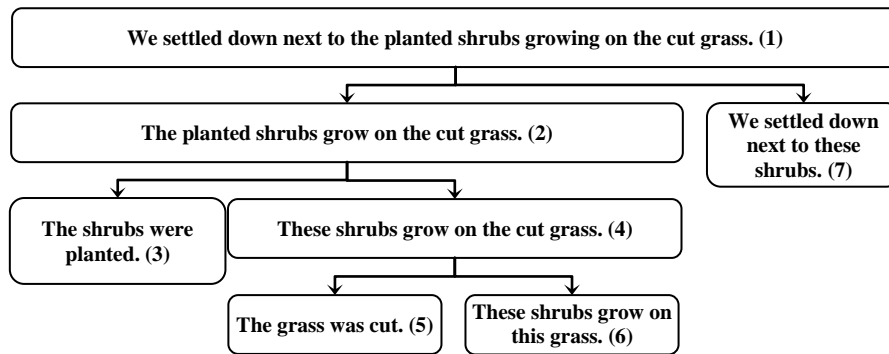

Fig. 1. Sentence Translation Tree

The construction of the tree continues for as long as splitting does, i.e. while at least one of the sentences triggers a certain conversion rule (out of the 14 rules developed). When the tree is filled, its nodes are processed in the following order: top, left subtree, right subtree. The processing order is shown on Fig. 1 by the number at the end of the sentence. Thus, the leaf nodes (whose subtrees are both empty) form the translation chain, namely: *[The shrubs were planted] [The grass was cut] [These shrubs grow on this grass] [We settled down near these shrubs]*.

IV. CONCLUSION

Each syntactic transformation rule provides the following functionality:

- Verification of the general usage conditions for rules of this type.
- Search for a multitude of constructions containing participles.
- Selection of a rule variant in accordance with set conditions.
- Implementation of various types of conversions depending on the chosen variant.

REFERENCES

- [1] M.G. Grif and O.O. Korolkova, "Development of systems for computer sign language," *International Journal of Advanced Studies* 2, no. 3, 2012.
- [2] M.G. Grif, O.O. Korolkova, and Y.B. Tsoy, "Development of Computer Sign Language Translation Technology for Deaf People regarding Russian Sign Language Peculiarities," *MERI Journal of Management & IT (Special Issue)*, vol. 5, no. 2, pp. 40-46, April 2012.
- [3] M.G. Grif, Y.A. Demyanenko, O.O. Korolkova, and Y.B. Tsoy, "Computer Sign Language Translation System for Hearing Impaired Users," *Proc. of The 7th International Forum of Strategic Technology (IFOST 2012)*. Tomsk: Tomsk Polytechnic University, vol. 1, pp. 617-620, September 2012.
- [4] M.G. Grif, Y.A. Demyanenko, O.O. Korolkova, and Y.B. Tsoy, "Development of Computer Sign Language Translation Technology for Deaf People," *Proc. of The 6th International Forum of Strategic Technology (IFOST 2011)*. Harbin: Harbin University of Science and Technology, pp. 674-677, August 2011.
- [5] O.O. Korolkova. "Morfologiya russkogo zhestovogo yazyka." *Lingvistika i mezhkul'turnaya kommunikatsiya: monografiya*, kn. 3. ["The morphology of Russian Sign Language," *Linguistics and Intercultural Communication: monograph*, vol. 3]. Krasnoyarsk: Research and Innovation Center, pp. 60-87, 2011.

Harmonic analyzer based on PWM method

Aravenkov Alexander

Novosibirsk State Technical University/Department of Automatics and Computer Engineering,
Novosibirsk, Russia

Abstract—The article describes harmonics determination using method based on pulse-width modulation (PWM), harmonic analyzer modelling and researching errors of harmonics determination, namely: influence number of PWM periods per harmonic period on harmonic determination error, influence PWM discreteness on harmonic determination error, influence harmonic phase on harmonic determination error, influence harmonic frequency deviation on harmonic determination error.

Keywords—spectrum analysis, harmonic analyzer, FFT

I. INTRODUCTION

Electrical signal form analysis, i.e. dependence of the voltage or current versus time, widely is used for getting information about various devices. However, time dependence does not have sufficiently high sensitivity of signal changing in some cases. Form of signal spectrum is significantly more sensitive. Signal presentation in frequency area as a harmonic sum with different frequencies, amplitudes and initial phases is also necessary in solving the electromagnetic compatibility problem, i.e. ensuring the work of many electronic devices in a limited frequency range. Using conversion nonelectrical quantities to electrical allows to use spectrum analysis in mechanics, acoustics, medicine and other area [1].

Currently, many devices based on Fourier method there are in a market. Method based on pulse-width modulation is alternative method of harmonic determination.

When Fourier method is used for harmonic determination, multiplication of function code and code value of sine/cosine component is calculated. This require using high computing power and large amount of memory in connection with the need to store both program code of the multiplication algorithm, and intermediate results, which are obtained in the course of the calculations. Multiplication operation of codes with storing results of multiplication is in fact excluded in proposed method, instead this analog multiplication of incoming signal and pulse-width signal of corresponding harmonics is performed and then

multiplication result is converted to the code using an integrating converter. Thus, computing power and amount of memory is reduced in this device by simplifying the calculation algorithm of harmonics.

II. SPECTRUM ANALYSIS BASED ON PWM METHOD

Main idea of spectrum analysis based on PWM method is as followed: for determination sine component V_{sin} , special pulse-width signal $P_{sin}(t)$ is generated corresponding to sine component of harmonic, which is multiplied by incoming signal $S(t)$ in analog form and then integral of multiplication result is determined. Result of integral is the value of sine component. The determination of cosine component V_{cos} of harmonics is similar to the determination of the sine, but instead of PWM signal $P_{sin}(t)$ special PWM signal $P_{cos}(t)$ is generated, for determination of cosine component.

$$V_{sin} = \frac{1}{T} \int_0^T S(t)P_{sin}(t)dt$$
$$V_{cos} = \frac{1}{T} \int_0^T S(t)P_{cos}(t)dt$$

Where T is period of research harmonic. At last step, harmonic module is calculated using followed equation:

$$V = \sqrt{V_{sin}^2 + V_{cos}^2}$$

Special PWM signal is generated for each researched harmonic. The necessary PWM signals is possible to obtain using the algorithm showed below.

Sine (for determination of sine component and cosine for determination cosine component) with period T is divided into n equal segments, in which center points C_i is found (where $i = 1 \dots n$ is number of PWM pulse) (figure 1). The value n represents the amount of the PWM pulses per harmonic period. Value of center point can be calculated using next formula:

$$C_i = T_{pwm} \left(i - \frac{1}{2} \right)$$

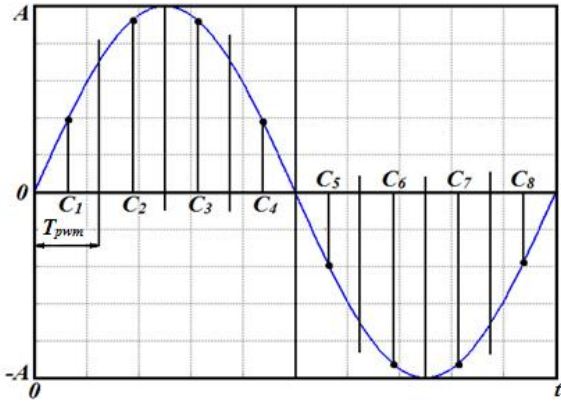

Figure 1. Finding of center point.

Square signal with amplitude A and pulse width τ_i (figure 2) is generated in this points. Pulse width can be finding using followed equation:

$$\tau_i = T_{pwm} \sin\left(\omega T_{pwm} \left(i - \frac{1}{2}\right)\right)$$

Where $T_{pwm} = \frac{T}{n}$ is a period of PWM signal, $\omega = \frac{2\pi}{T}$ – circular frequency.

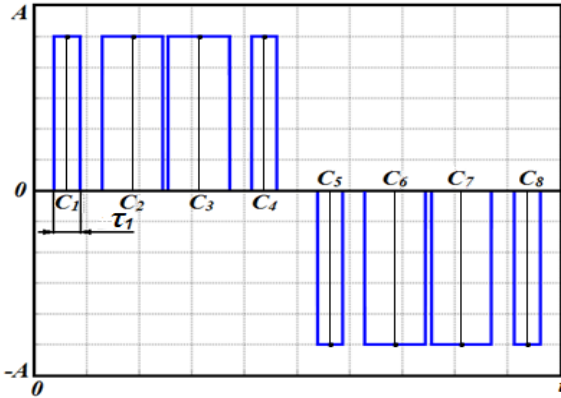

Figure 2. PWM signal.

If it is need to determine harmonic with number k , then sine/cosine frequency must be increased k times.

It is also worth noting that this method of determining the harmonic components of the signal is a vector that allows to determine both the amplitude and phase of harmonics. Found sine and cosine components of harmonic it is easily to determine phase of harmonic using next equation:

$$\varphi = \tan^{-1}\left(\frac{V_{sin}}{V_{cos}}\right)$$

III. RESEARCH

This method of harmonics determination of signal is new, therefore, factors influence on error of harmonic determination is unknown. For the purpose of researching this factors, modeling of harmonic analyzer was done, in the course of which was researched:

- influence PWM discreteness on harmonic determination error;
- influence number of PWM periods per harmonic period on harmonic determination error;
- influence harmonic phase on harmonic determination error;
- influence harmonic frequency deviation on harmonic determination error.

Modelling was done in MatLAB with using programing language of the same name. Written program is fully corresponded to algorithms of harmonic determination and PWM signal generation are presented above.

Influence number of PWM periods in one harmonic period on harmonic determination error (PWM discreteness error). PWM discreteness error means how much points are taken for generation the one PWM period. This error is related to discreteness of forming of time intervals. In order to study the behavior of this error in dependence on number of points in one PWM period sine signal was used. Changing the number of points in one PWM period harmonic was calculated. Modelling was done for different number of PWM pulses in one harmonic period.

In figure 3 shown that when using a sufficiently large number of points for the PWM period, fluctuations of plots is reduced and tend to the value equal to the error depended on the number of PWM pulses for the period studied harmonics.

Analyzing Fig. 4 and 5, it can be concluded that after a 500 points per PWM period, fluctuation becomes small.

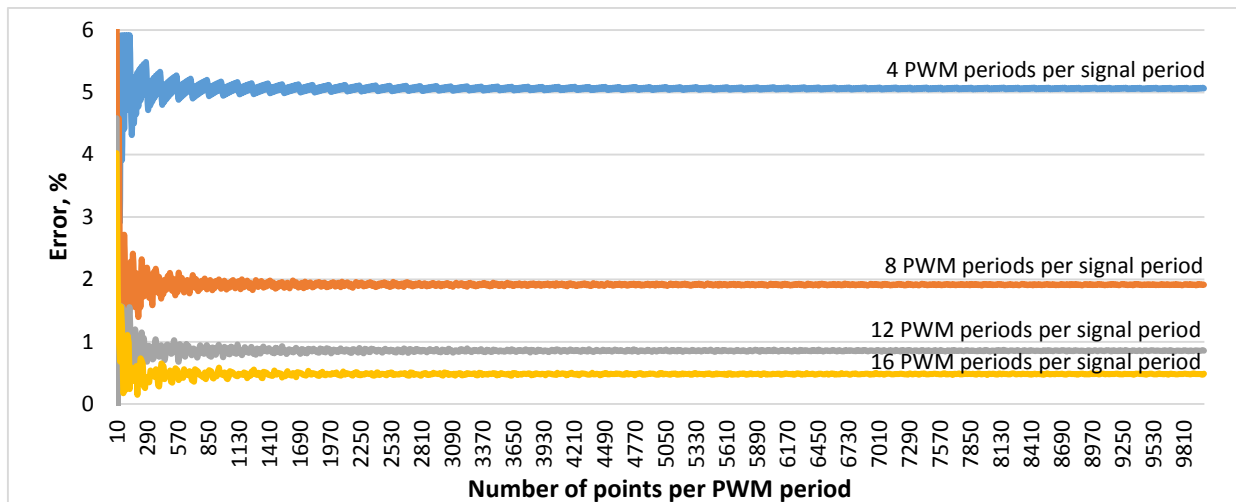

Figure 3. PWM discreteness error for 4, 8, 12, 16 PWM pulses in one harmonic.

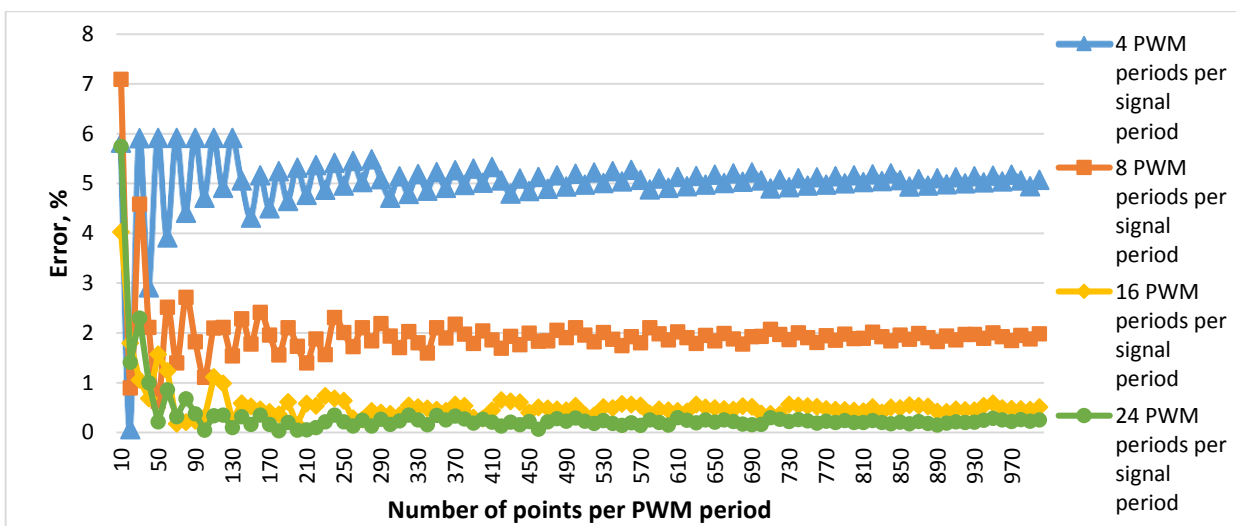

Figure 4. PWM discreteness error for 4, 8, 16, 24 PWM pulses in one harmonic.

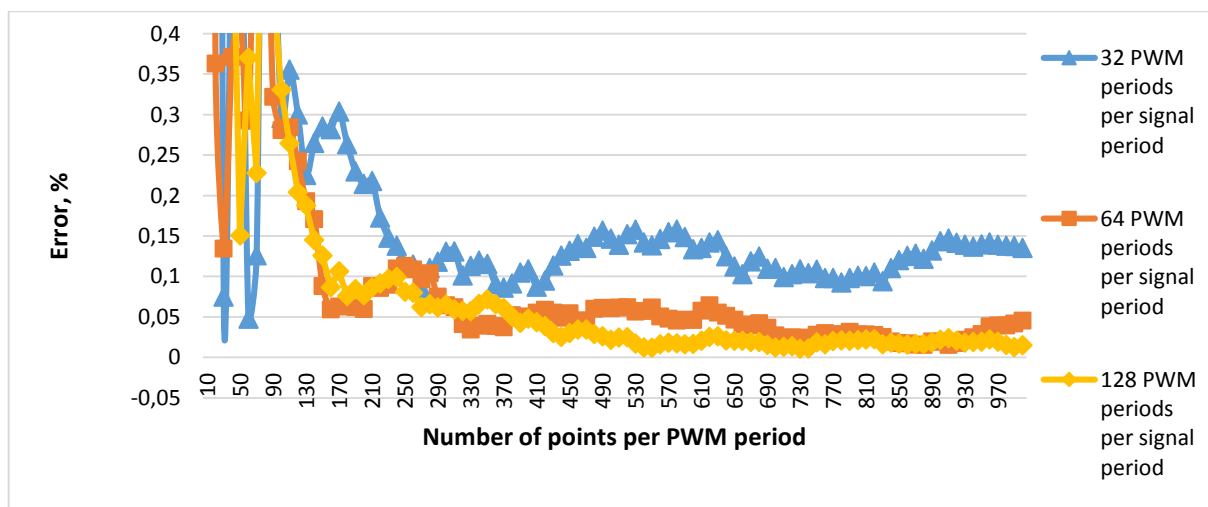

Figure 5. PWM discreteness error for 32, 64, 128 PWM pulses in one harmonic.

It is worth noting that the increasing the number of points per period of the PWM, increasing the sampling rate requirements. For example, to measure signal with frequency equal to 2kHz using 500 points per PWM period and 16 PWM periods per harmonic period, it is need , the sampling frequency need $F_d = 2000 * 500 * 16 = 16 \text{ MHz}$.

Influence number of PWM periods per harmonic period on harmonic determination error. In modelling sine signal was researching. Changing number of PWM pulses per harmonic period, harmonic was measured. In order to reduce influence of PWM discreteness error, PWM signal formed with 10000 points per harmonic period. Fig. 6 and 7 shows that in range from 2 to 9 PWM pulses per harmonic period, error sharply reduced to 1.5%. Further increasing of PWM pulses per harmonic period error begins to decrease gradually and at 128 PWM pulses error is set 0.007%.

Influence harmonic phase on harmonic determination error. Modeling was done for sine input signal. Changing phase of input signal, harmonic measuring was made. As expected phase of signal does not influence on harmonic determination error because this method is vector.

Influence harmonic frequency deviation on harmonic determination error. Modelling of this error was done for input signal $f(t) = A \sin(2\pi ft + \varphi)$, where $f = f_0 + \Delta f$, f_0 is a nominal frequency and Δf is a deviation of frequency. Frequency was changed in range $\pm 1\%$ of nominal frequency. Modelling was done for 16, 32 and 64 PWM pulses per harmonic period.

Summarizing obtained results (Fig. 8), it can be concluded that error depended on harmonic frequency deviation is almost not depend on number of PWM pulses per harmonic period and it is a part of harmonic determination error.

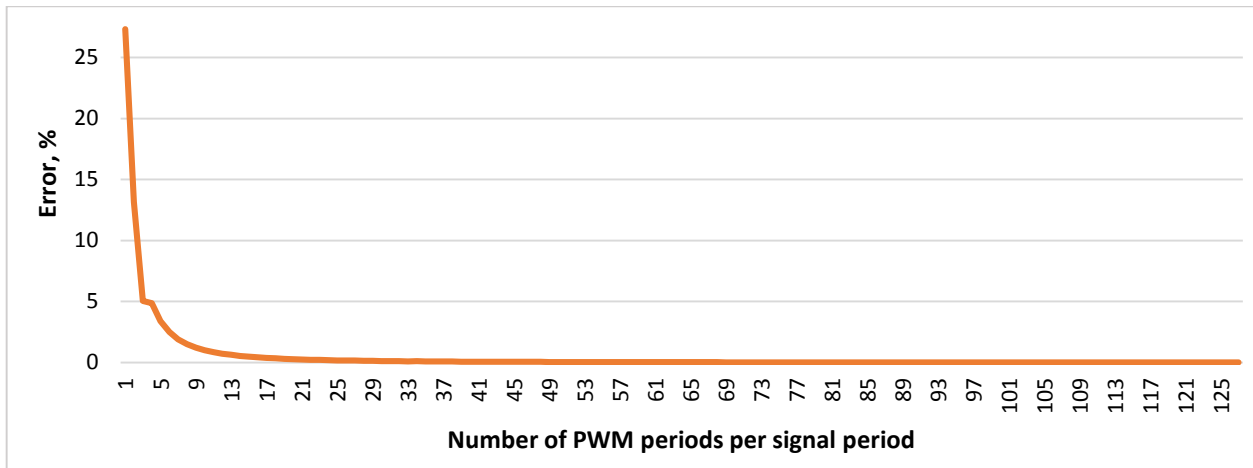

Figure 6. Influence number of PWM periods per harmonic period on harmonic determination error.

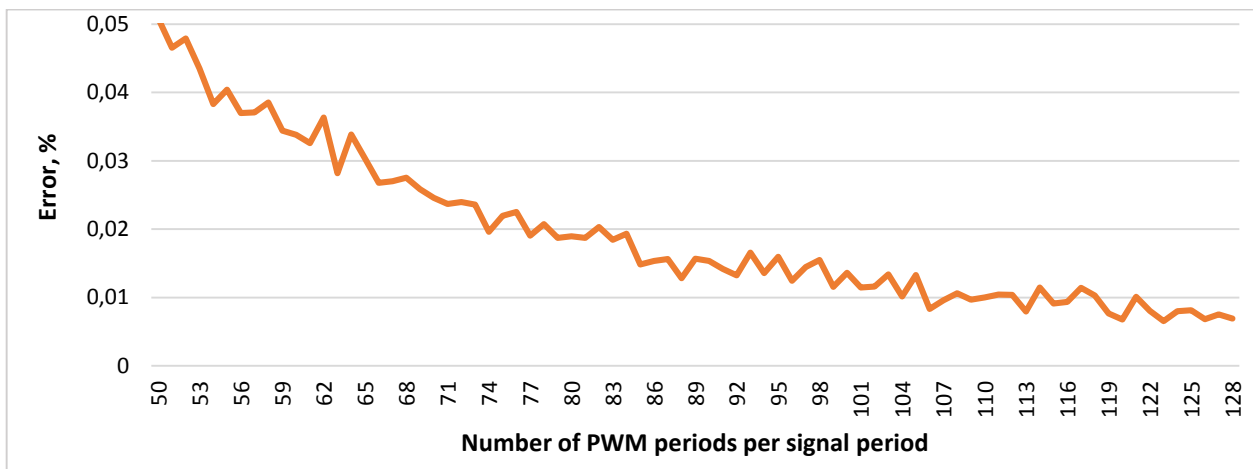

Figure 7. Influence number of PWM periods per harmonic period on harmonic determination error.

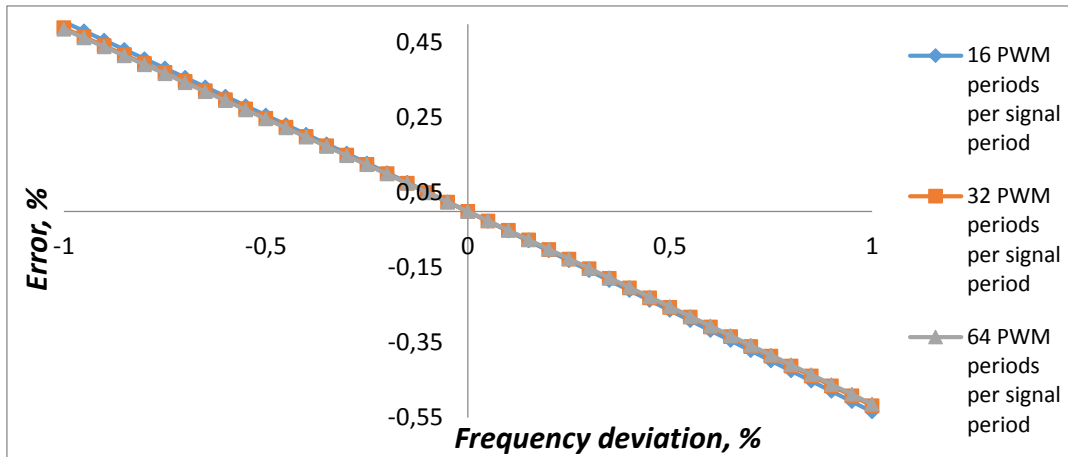

Figure 8. Influence harmonic frequency deviation on harmonic determination error for 16, 32 and 64 PWM pulses per harmonic period.

IV. FUNCTIONAL DIAGRAM OF THE ANALYZER BASED ON THE PWM METHOD

Functional diagram is shown on Fig. 9. The input signal is applied to the switch S and the inverting unit IU , which is connected with a switch. Switch is toggled by PWM signal applied from microcontroller M . When the output of the microcontroller control is a "positive PWM" then signal passes through switch. When the output of the microcontroller control is a "negative PWM" then signal passes through inverting unit and switch. And when the output of the microcontroller control equal zero there is zero on switch output. This process is equivalent to multiplication of input signal and PWM signal. Thus, we get multiplication of researched signal and PWM signal on output of the switch.

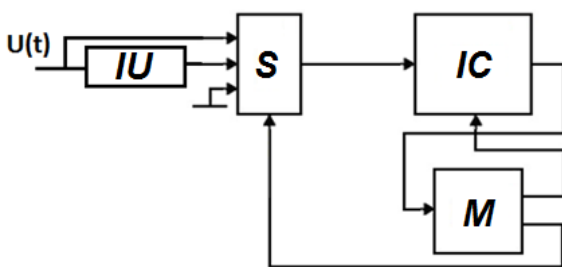

Figure 9. Functional diagram of the analyzer based on the PWM method.

Output of switch is applied to integrating converter IC, and where multiplication of input and PWM signals converts to voltage, time, etc., that proportional of sine or cosine component of researched harmonic, depending on PWM signal type.

Data from output of IC applied to microcontroller having ADC, where data is processed and then either

gone to indicator or transmitted for subsequent use via any interface.

V. CONCLUSION

In operation, the mathematical model was developed that describes the method of determining the harmonics of the signal based on the PWM, as well as using this model various factors affecting the common method error in the determination of harmonics have been investigated.

The research have shown that the error of discreteness makes negligible contribution to the common method error using 500 points per PWM period. The error depending on number of PWM pulses per harmonic period is equal to 0.4% for 16 PWM pulses. Further increasing number of PWM pulses slowly reduces of error. For 128 PWM pulses, the error is 0.007%. As expected, harmonic determination error does not depend on phase, because this method is vector. In addition, the error depend on harmonic frequency deviation. This dependence is linear and substantially independent of the number of PWM pulses per period of the harmonic.

This method of harmonic determination is well work in area of low frequencies providing a small error (0.5% at 16 PWM periods per harmonic period and at 500 points per PWM period). Method can be used in the area of determining of electricity quality and in PLC networks.

REFERENCES

- [1] Khristoforov A.V. Metody analiza spectra signala [Methods of analysis of the signal spectrum]. Kazan : KSU, 2004. 21 p. (rus)

[2] Bystrov U.A.,Mironenko I.G. Elektricheskie tsepi i ustroystva[Electronic circuits and devices]. Moscow : HS, 1989. 287 p. (rus)

Mediator in social Environments

Anke Tallig

Chemnitz University of Technology Department of Computer Science, Chemnitz, Germany

Abstract — Robots in social environments, which are dominated by human beings, need more comprehensive social awareness. As a consequence, an additional social feature for these robots is necessary. An ability, which the technical device requires to react to human beings in social situations and therefore to adjust its own behavior accordingly. This paper describes a method to perceive the non-verbal communication of human beings in social environments. With the perception of the human body language the robot receives additional information about the environment and the social situation. Thereby it interprets the behavior of humans in current social situations and mediates between human and premise and also between human and the technology itself. This competence is a step in the direction of an individualizing human-robot communication.

Keywords — robot mediator, perception, companion, human-robot interaction, non-verbal communication, automatic system.

I. INTRODUCTION

Robots in environments which are dominated by human beings need more comprehensive social awareness. At present, robots perceive gestures as a special kind of communication and facial expression as emotion. This happens at a closer distance to the robot or the system in general. Perception in such a close environment is important to individualizing the human-robot communication. This special communication takes place in different environments [14], for instance in exhibition areas, old people's home, private home areas, as advertiser in service areas and also in museums.

At present many museum robots have been realized and a lot of different achievements have been described [14]. For example the interactive tour-guide robot *RHINO* [3], it's primary purpose is the safe navigation through the museum and the crowds and also the interaction with people. Visitors of the museum can send it to a specific target location in the museum via a web interface. *Minerva* [18] is also a museum robot which affects the people on a social level. It can express four emotions with a mechanical face: smile, neutral, sad and angry. But the primary purpose is also the navigation through the environment. The three robots in the "Museum für Kommunikation" in Berlin, *Komm-rein*, *Also-gut* and *Mach-was* [6] are darlings of the public. They combine the navigation feature and the social aspect. These robots have individual navigation areas and also a special character. This character decides in which way they communicate with the visitors. A special feature which the

visitors like, is the interpersonal communication of these robots. One further step goes *Robotinho* [5]. It explains the exhibits. It guides the visitors through the exhibition and presents the exhibits in the guided tour. In front of every exhibit which is in the guided tour it explains some basic points and subsequently it asks: Do you want to know more about this exhibit? It listens to the answers and decides by the loudest and cleanest voice. In this way a communication situation is built. The newest museum robot is *I²MSAS* [8], [11] developed by the HTW Dresden. This robot contains features of navigation, presentation and interaction. More than save navigation through the museum area, it make the exhibits alive. It seems to the visitor that the exhibits still work. This is implemented by a projection. Thereby a interaction between human and information and between human and robot is realized. At present, it's the most sophisticated robot in this area.

All these present projects realize social individualization via facial detection, verbal requests or manual input with the help of suitable displays. These implementations were made for small spatial distances. But a natural communication situation begins with the first eye contact which happens at a major distance.

The aim of the project, which is described in this paper, is the perception of social situations at a major spatial distance. With the help of this special information the robot appears as a mediator between human and environment on the scene. Thereby the robot affects the wellbeing of the visitors.

II. EDGE OF THE HUMAN BEING

That, which is the edge of the human beings, that is the handicap of social robots at human-robot communication at this time.

Recognition of natural interpersonal communication in public spaces has changed over the years [10]. It consists of three basic stages. It begins with the very first eye contact in a major spatial distance. The first awareness effects our attitude of a person and it's decides if we like or don't like this person. Then follows the awareness in a closer distance, which specifies the opinion of this person. But this opinion can also be completely changed by the additional information. During a verbal dialog we acquire the details of our communication partner. The sum of these three stages decides how we talk together, if we like or don't like the counterpart and it decides on which social level we talk together [9]. The first two steps make use of non-verbal communication in contrast to the third one. We are aware of non-verbal signals at major distances, we interpret these signals and form an opinion of our counterpart. We use these non-verbal signal more

unwittingly than wittingly [1]. That's why it's good to estimate the intension of the communication partner. Because by doing this unwittingly, we cannot not communicate. In a interpersonal communication we use the non-verbal signals to show our intension, sympathy and social status [13], [9].

At present the ability of robots consist of the second and the third step (see above). But the first impression of the communication partner is lost. As a consequence robots need a social ability so that they can perceive their human counterparts in a major distance and use the human non-verbal signals to interpret their intensions.

III. MEDIATOR

The component, which perceives the human non-verbal signals, is called *mediator*. This name is used because the perception component is helpful to lead and to mediate the people in social environments. The mediator mediates between the humans and the environment and also between the humans and technology itself [16]. Temporarily it's a companion [2], [4] of the people which facilitate the orientation in different unknown environments.

Facilitation of orientation is a helpful ability of a robot because this skill affects the wellbeing of the people. They don't need to know how the system works or how they have to use it. The system reacts proactively and so a barrier between human and technology is hurdled.

A. CONCEPT

The mediator component which detects the body language of people in social situations, is one part of a whole concept [17]. The first prototype of the mediator perceives humans at the entrance area of museums.

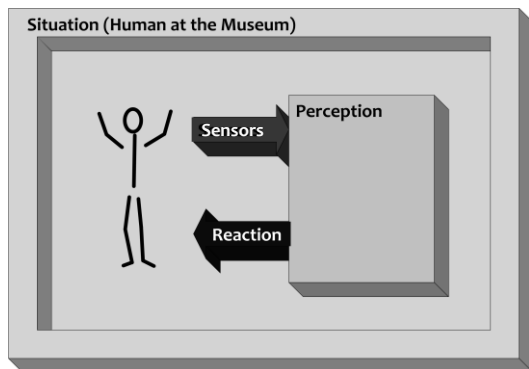

Fig. 1. Depiction of Situation.

In figure 1 is shown the situation and the perception. The construction of the perception based on the E-V-A principle. E stands for "Eingabe" (Input). The input data is provided by the optical sensor, which is a combination of a VGA camera, a infrared projector and infrared camera. V means "Verarbeitung" (processing). All different data of distance, position and behavior are handled inside this processing unit. A for "Ausgabe" (Output) realizes the verbal reaction to the situation.

The processing unit needs a special pattern of the non-verbal signal to compare it with the perceived data. Because of the used optical sensors not all signals can perceive. Non-verbal communication is the amount of facial expression, gestures, postures, body contact, proxemics, clothes and other human physical appearance, phonetic statements and also smell [1]. With the help of a optical sensor postures, proxemics and the physical appearance like the height of a person can be perceived.

Therefore the interpretation of social situations based on a spatial social distance (see B. Implementation), the social human posture (ibid.) and the height of the person. Due to the calculation of the height can be detected if the person a adult or a child. With the help of this information the verbal reactions are adjusted.

B. IMPLEMENTATION

The implementation follows a three part concept of perception. These three parts of perception are:

- distance
- human detection
- posture calculation.

Distance is an important detail. Not every distance is suitable to perceive non-verbal signals. Edward T. Hall differs five areas of interpersonal communication [7], which are signalized by different signals of communication.

Two different areas of communication were implemented. First, the communication area itself in a distance of 0,9 m to 3,6 m. In this distance the detection of human beings has been realized. Second, the security area with a radius of 0,9 m around the robot. E. T. Hall called this area intimate area. This area isn't suitable to perceive such a social communication which is preferred in this project. The distance of more than 3,6 m is named public area. This area isn't a communication area and for that reason not observed.

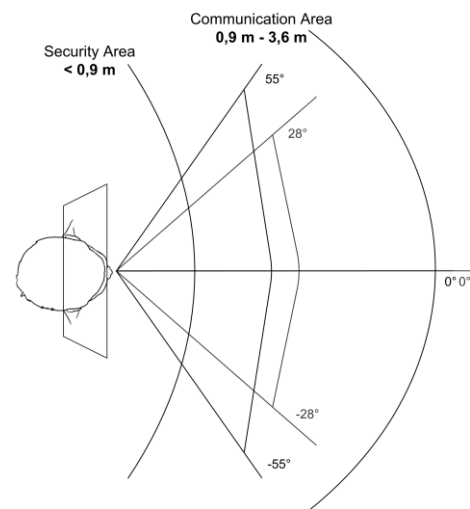

Fig. 2. Implemented Areas; View of Human vs. View of Sensor.

Figure 2 shows the implemented areas of perception. It was compared to the human field of view (black 55°) and

the sensor field of view (grey 28°). Also depicted is the sensor area, it's adjusted to the social human areas by Edward T. Hall [7]. As a consequence the sensor reacts at the same distance level as a human being.

The difference of 27 degrees between human field of view and sensor field of view seems massive. But the sensor perceives in this area three-dimensional objects and the full scale of color. A human being can only see the full range of color in a area of -15 degrees to 15 degrees [12]. So the sensor is more precise than a human eye in the whole perception area.

Part two of the implementation is the human detection. This happens with suitable points of the human body. All joints, which connect the human body parts, are suitable. The configuration of these points allows building a pattern of the human body. With the help of this pattern the input data of the sensor can be compared.

Part three is the most important part of the implementation. This part realizes the perception of the non-verbal signals. One cannot not communicate [19] that's the reason why this kind of perception works. But with all enthusiasm we should see scratching the nose as scratching the nose. We shouldn't interpret all human body movement and we also can't perceive all this movements with the help of a sensor.

What is perceptible? At this special distance all body movements which are extroverted. If we use our whole body including arms and hands then it's a good posture to perceive it. There are many different postures that human beings use to communicate. They differ from environment to environment also from culture to culture. So it is important to be precise in the environment of the perception and the special area. Because in the entrance area human needs are different to the needs in the exhibition area. If we know the needs of the humans in an entrance area, we have to observe how they communicate these needs in a non-verbal way. One example of the huge amount of non-verbal signals is shown in figure 3. Posture in figure 3 is called "What are we going to do now?". With the arms akimbo the person enlarges the body surface. In this posture the person has no problems with attackers. This is a typical posture of 'I know what I want and I'll defend my opinion'.

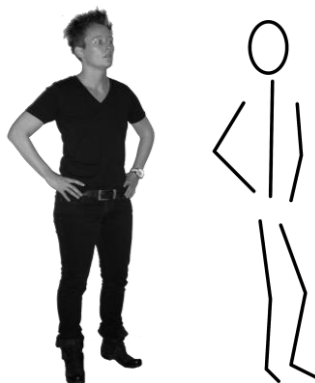

Fig. 3. Non-verbal Signals in real and virtual.

With the perception of such body postures a system can be socially emphatic [15]. This ability allows the system

to interpret the needs of human beings in social situations. The result of interpretation is used to react suitably.

For the perception of the human body, posture is used as the geometry of the body. This is hinted in figure 3, left picture draws the geometry of a human body. With the help of this essence a calculation of the position of all body parts can happen. The calculation contains the absolute position of the body parts and also the relative position to other parts. The relative position is calculated by vectors of the parts and angles between the body parts. With the results of these calculations a pattern of every non-verbal body posture is build. By comparison between pattern and sensor data the processing unit decides which body posture was made by the human being. On this information is grounded the verbal reaction of the mediator component and in succession the verbal reaction of the social robot.

C. EVALUATION

The evaluation has been executed on two levels: The first level was the reliability of perception and the second was the acceptance of the perception system.

The reliability of perception was tested on two different light conditions. First iteration at 30 lux, this is the lowest light intensity on which the sensor works. Second iteration on 100 lux. This light intensity was used because there is a restriction (DIN EN 12464) to museums which states how strong the light intensity in the different areas of the museum must be.

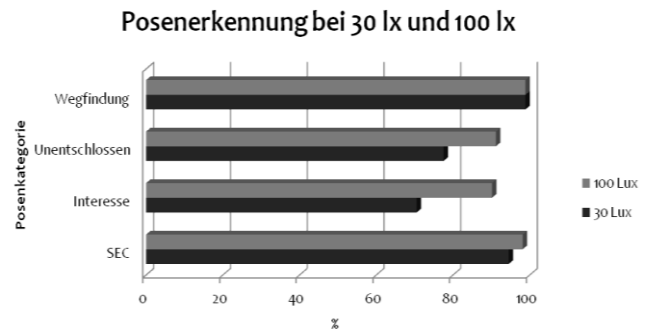

Fig. 4. Reliability of Posture Perception at Different Light Intensity.

Figure 3 describes results of the evaluation. The reliability of the perception differs from the three situations which are called "Wegfindung" (path finding), "Unentschlossen" (indecisive) and "Interesse" (interest). Postures of path finding are more extroverted than the other postures. As a consequence the reliability of perception of these postures is better. The disregard of the security area (SEC) is better detected at brighter light conditions (100 lux). The total result of reliability is with a light intensity of 30 lux 82,7 % and with a light intensity of 100 lux 93,7 %.

At this time the acceptance of the perception system has been analyzed. What can be said is, it's a new ability for robots. In general it can be said the people like it, only some are uncertain. They can imagine this technology could also helpful in different other environments.

IV. CONCLUSION

The content of the paper describes a technical system, which mediates between human and environment and also between human and the technology itself. This happens by the perception of non-verbal signals which are used by human beings in interpersonal communication. The implementation realizes the perception of special non-verbal signals, which are used by human beings in an entrance area of exhibitions. Results of the executed evaluations illustrates a reliable technical perception and a social acceptance.

This project needs more information about social postures in different social environments. This information is needed to improve the quantity and more important the quality of the social non-verbal signals.

With the help of the perception of non-verbal communication a barrier between human and technology is hurdled. The users don't need special information also how the system works and how they have to use it. They only communicate with their body language. Also the technical device gets an edge: It "knows" what users need by the perception of their non-verbal signals. This knowledge is an important step in the future of proactive systems – no operator terminal, no complicated use, no special technical information.

Don't tell me what you want; Show me what you want. I'll see it on your body language. I'm ready if you're ready!

ACKNOWLEDGMENT

The author thanks the DFG Deutsche Forschungs-Gemeinschaft for supporting the research training group *CrossWorlds – Connecting Virtual and Real Social Worlds*. Also thanks to the department of computer science, professorship of computer engineering and professorship of media informatics of the Chemnitz University of Technology.

Special thank you to Richard Brunner for his linguistic support and furtherance.

REFERENCES

- [1] Argyle, Michael, „Körpersprache und Kommunikation, Nonverbaler Ausdruck und Soziale Interaktion“, Paderborn: Junfermann Verlag, 2013.
- [2] Biundo, S. and Wendemuth, A., „Von kognitiven technischen Systemen zu Companion-Systemen“, in *Künstliche Intelligenz* (2010) 24, pp.335-339.
- [3] Burgard, W. et al., „The Interactive Museum Tour-Guide Robot“, in *Proc. of the Fifteenth National Conference on Artificial Intelligence (AAAI-98)*, Madison, Wisconsin, 1998.
- [4] Dautenhahn, K. et al., „What is a Robot Companion – Friend, Assistant or Butler?“, in *IEEE/RSJ International Conference on Intelligent Robots and Systems, 2005, (IROS 2005)*, pp.1192-1197.
- [5] Faber, F. et al., „The Humanoid Museum Tour Guide Robotinho“, *The 18th IEEE International Symposium on Robot and Human Interactive Communication*, Toyama, Japan, 2009.
- [6] Graf, B., Baum, W., Traub, A. and Schraft, R. D., „Konzeption dreier Roboter zur Unterhaltung der Besucher eines Museums“, in: *VDI-Berichte 1552*, VDI-Verlag 2000, pp.529–536.
- [7] Hall, Edward T., „The hidden dimension“, United States of America: Anchor Books, 1966.
- [8] Hellbach, Sven, Bahrman, Frank, Donner, Marc, Himstedt, Marian, Klingner, Mathias, Fonfara, Johannes, Poschmann, Peter, Schmidt, Richard and Böhme, Hans-Joachim, „Learning as an essential ingredient for a tour guide robot“, in *Machine Learning Reports 02/2013, Workshop New Challenges in Neural Computation 2013*.
- [9] Mehrabian, Albert, „Significance of Posture and Position in the Communication of Attitude and Status Relationships“, in *Psychological Bulletin*, Vol. 71, No. 5, 1969, pp. 359-372.
- [10] Pernack, Roman, „Öffentlicher Raum und Verkehr – Eine sozialtheoretische Annäherung“, *Discussion Paper SP III 2005-104*, Wissenschaftszentrum Berlin für Sozialforschung, 2005.
- [11] Poschmann, Peter, Hellbach, Sven and Böhme, Hans-Joachim, „Multi-modal People Tracking for an Awareness Behavior of an Interactive Tour-Guide Robot“, in C.-Y. Su, S. Rakheja, H. Liu (Eds.), *ICIRA 2012, Part II, LNAI 7507*, Springer 2012, pp. 666–675.
- [12] Schenk, Joachim and Rigoll, Gerhard, „Mensch-Maschine-Kommunikation, Grundlagen von sprach- und bildbasierten Benutzerschnittstellen“, Berlin Heidelberg: Springer Verlag, 2010.
- [13] Scherer, Klaus R., „Nonverbale Kommunikation“, in Scherer, K. R. & Wallbott, H. G., „Nonverbale Kommunikation: Forschungsberichte zum Interaktionsverhalten“, Weinheim: Beltz, 1979.
- [14] Schraft, R. D., Hägele, M and Wegener, K., „Service Roboter Visionen“, München: Carl Hanser Verlag, 2004.
- [15] Tallig, Anke, „Sozial empathische Systeme coram publico“, in Hasselbring, W. and Ehmke N. Chr., *Software Engineering 2014, Fachtagung des GI-Fachbereichs Softwaretechnik*, Kiel 2014 LNI 227, pp.107-112.
- [16] Tallig, Anke, Hardt, Wolfram and Eibl, Maximilian, „Border Crosser: A Robot as Mediator between the Virtual and Real World“, in A. Marcus (Ed.), *DUXU/HCI 2013, Part III, LNCS 8014*, Heidelberg: Springer 2013, pp. 411-418.
- [17] Tallig, Anke, „Grenzgänger-Roboter als Mittler zwischen der virtuellen und realen sozialen Welt“, *Chemnitz: Chemnitzer Informatik-Berichte CSR-12-05*, 2012.
- [18] Thrun, S. et al., „Probabilistic Algorithms and the Interactive Museum Tour-Guide Robot Minerva“, in *International Journal of Robotics Research*, Vol. 19, No. 11, 2000, pp.972-999.
- [19] Watzlawick, Paul, Beavin, Janet H. and Jackson, Don D., „Die Unmöglichkeit, nicht zu kommunizieren. Menschliche Kommunikation“, Bern Stuttgart Wien; Huber, 1969, p.53.

Management System for University Topics Based on Homogeneous Object Binding Structure

Daniel Reißner, Wolfram Hardt, Technische Universität Chemnitz, Germany

Abstract— University administration requires for fast ready to use tools for dynamic changing needs. Existing frameworks by abstraction, hiding access to required functionality or access it with effort. Therefor the flexible homogeneous object binding concept is implemented for thesis management system resulting in wide range usable new features presented following. Index lifting brings the full relational performance of index access for huge amount of data, while object links abstract complexity as far away from prototype, as required, by self-organization.

Keywords— flexible, adaptive, generic, preference gradient, model view controller

I. INTRODUCTION

Intuitive grouping of parts of real world to common objects seems widely accepted. This way directly mapping of requirements, requests and updates to object binding seems easier to understand than relation sets.

Google tools like drive or calendar brings the effort of saving data externally [1]. Relational database system is very widespread and performant. A historical reason is higher flexibility of operations of sets in relational model compared to error prone reassign of all pointer structures in pointer based databases [2]. Because of limitations of access paths object oriented databases may result in lower performance compared to relational databases and have limited widespread [3]. Document based databases like mongo DB could not provide the robustness of mature relational systems e. g. fully consistency, fully supported ACID rules [4], [5].

Limitation for incorporation of document based system with flexible data saving and relational system where the inconvenient growing access times [6]. It seemed two not fitting systems where available.

In this paper the concept of homogeneous object binding structure is realized in form of objects in relational database system. At the same time by the dynamic table structure flexible structures similar to document based systems are established. Document based database systems accessing unstructured files in inconsistent possible format by identifiers. In contrast to document based system, homogeneous object structure extends objects structured in object types (person, topic) and allows a homogeneous format for all applications common access, by at the same time flexibility in content by further processing dimension. To realize in relational schema it is possible to create a table per object.

Following homogeneous architecture is described and advantages of intuitive clear by at the same time high flexibility over grouping and typecast are presented.

II. SYSTEM ARCHITECTURE

Management System realizes model-view-controller architecture. The model is realized by homogeneous object binding structure. It realizes a general object to which real world application parameters are dynamically bound in form of key value pairs. Thereby hierarchies and layers are realized. This structure is basis for preference based decisions and in this context possible becoming dynamic gradient structures. The gradient structure [7] can represent very flexible requirements of order tasks as used for thesis progress controlling in this tool.

An Object-type-object groups all objects of a type like persons Fig. 1. Separate Object tables hold only the currently needed key-value pairs saving memory for much default values. Concept of object links allows a controller to resolve the object type and id to referenced table. Furthermore keys could be referenced by appending them to object link. Other than with simple foreign key, object link allows from this structure information to get automatic self-organized the target table of an object type and provide generic operation of extraction of name of target for view.

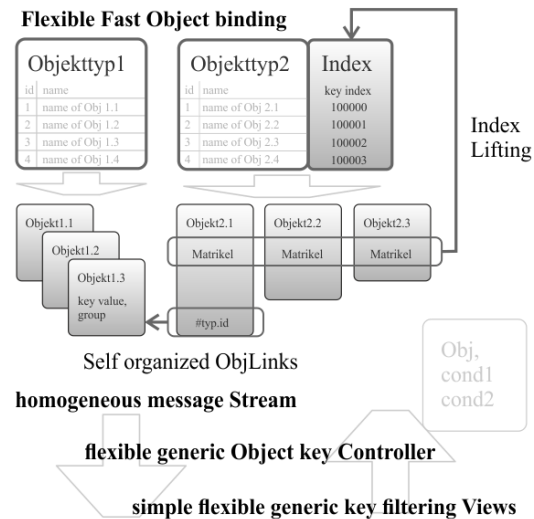

Fig.1. Homogeneous object-binding architecture concepts

In order to combine relational Database with homogeneous data from a document based view in a performant way, concept of index lifting is introduced. Index Lifting allows moving often used or in many objects available key values in an object type index Fig. 1. This way fast access to required data is possible while flexible access to dynamic data is still available.

Controller is organized in separate PHP files for operations on homogeneous object binding structure. Operations are generic by working on parameterized object type and id. Provided operations are retrieving of filtered objects and statistics data and update of not further to process data, object links, gradient process state and deadlines. Generic filtering of keys in update stream allows for sending emails and upload of files.

Object links are automatically resolved if not other specified. In case of foreign key editing properties for a view, it is required to display the resolved name while hidden represent the id to later assign the data to correct point. A generic view object allows for filtered object information selection combined with optional autocomplete input and hidden id input mapped to the object link requirements. This GUI element was of high reuse Fig. 3 three dot button, loading objects of type filterable by object conditions.

In the view the homogeneous json stream pays out its advantages. By simply flexible adding GUI input elements with object link property they were by generic controller automatic inserted in database or read out. This enormous flexibility may be restricted in more public GUIs by access rights key-value attributes or column to restrict access by security levels. Shibboleth authentication which is integrated allows distinguishing between student and member, activatable for further security restrictions.

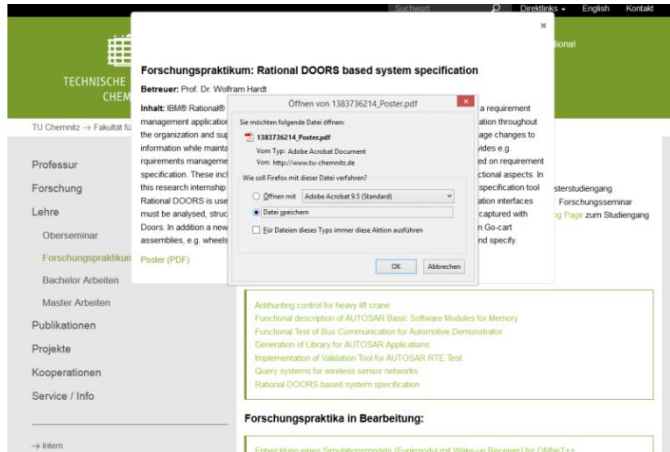

Fig. 2 overview over available internships (bachelor, master thesis) object stream auto generated from available type and self-organized resolved object information; including file object with database-stored pdf resolving

III. RESULTS

Overview of internship, bachelor thesis and master thesis used generic object link to generate view as shown in Fig. 2. Advantage of controller is that it automatically resolves text in case foreign objects are not connected or realized yet. This way easy extension by new objects is possible by changing from textual description to self-organized object link resolving for new objects. Implementation of student localized view Fig. 3 and advisor view Fig. 4 was realized. Advisor view allows for processing of current tasks in progress of current thesis for easy controlling. The managing is realized by gradient structure in database with preference Gradient nodes. Such nodes hold object link to previous and next node in partial order and all

relevant GUI information to generate the view e. g. button actions, mail default texts, form names.

This Site is under construction. On this page it is possible to reserve a topic.

- Matriculation number is required.
- Poster in PDF format can be uploaded later too.
- User data can be changed later too.

Login:

First name:

Surname:

Matriculation number:

Email:

Group affiliation:

Organisation:

OrganisationID:

Type of Topic: Master thesis Internship Bachelor thesis

Topic: ...

Begin:

Poster (PDF): Keine Datei ausgewählt

Fig. 3. English localized Version of Student thesis reservation site

File object was realized integrating unique name of topic and editor in meta-symbols not allowed in filenames. Object links connect topic and file allowing pdf filtered storage by student view Fig. 3 and check Fig. 3 and overview Fig. 2.

Stammdaten Betreuer Studierende

Stammdaten

Student Betreuer Person suchen Thema suchen Thema anlegen Thema bearbeiten

Übersicht

Thema anlegen

Thema: 1, Daniel Reißner 2, Daniel Firma Reißner 3, Danielm1 Reißner 4, Stephan Blokzyl ...

Betreuer:

Betreuer Ort (intern, extern):

Betreuer2: ...

Betreuer2 Ort (intern, extern):

Bearbeiter: ...

Status: ausgeschrieben in Bearbeitung abgeschlossen

Typ der Arbeit: Masterarbeit Forschungspraktikum Bachelorarbeit

Aufgabenbeschreibung:

Anforderung:

PDF Link:

Literatur Link:

Fig. 4. advisor view with possibility to create persons (students, intern, extern advisors), topics, update topic state and get current progress overview from overview; dynamic generated search forms for objects

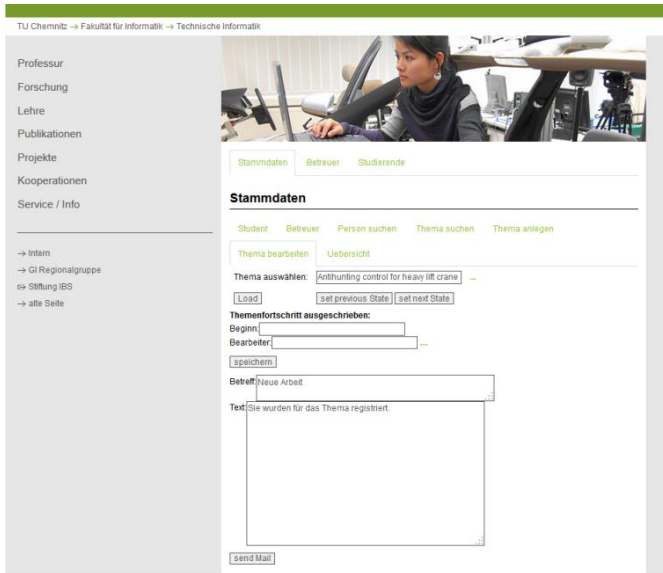

Fig.5. dynamic from gradient process node generated form for state processing (e. g. ausgeschrieben), State progress changes are direct reflected in view e. g. by moving topic from “ausgeschrieben” to “in Bearbeitung”; E-mail predefined text save controlling time processing current thesis progress.

Integrated Framework Bootstrap was used as basic styling framework. Views GUI elements naturally integrate jquery window, autocomplete and calendar functionality. For simple code where possible for request and response of ajax streams jquery was used, using delegation approach for up to date dynamic generated java script with fall back to generic java script where required. In order to display filtered homogeneous messages streams in diagrams (Fig. 6) the jquery plotting plugin jqplot was used. Fullcalendar for Calendar display and Baikal for display of calendar on smartphone were considered.

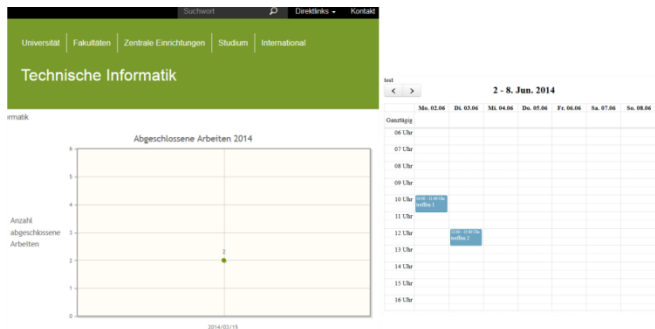

Fig.6. homogeneous object binding structure allows for simple filtered display of statistics data; as outlook calendar functionality could be integrated but for common solution may be preference for existing services

IV. CONCLUSION AND OUTLOOK

In this work a flexible thesis management system using homogeneous object binding structure was presented. Flexible structure allows for storage of only required data. Object links allow for self-organisation. Index-lifting allows high performance of relational database indexed access. The usage of homogeneous stream controlling allowed simple implementation of strong control mechanisms over high complexity by extra structuring dimension.

Extension by restriction of gradients steps to certain study regulation is planned. Versioned File processing is planned, extending file object with blobs binary data by file objects with key value pairs for line text, line version group, line-limit free generic attributes of files. This file objects could further be used for specification, overview or simulator tools. Timely animation requirements or connections and graphical elements could also be stored and loaded from such files.

REFERENCES

- [1] Common Google tools: <https://drive.google.com/>; <https://www.google.com/calendar>, June 2014.
- [2] Relational Database Objects and Pointers http://www.dba-oracle.com/t_object_relational_data_pointers.htm, June 2014.
- [3] <http://de.wikipedia.org/wiki/Objektdatenbank>, June 2014.
- [4] Document-based database systems http://de.wikipedia.org/wiki/Dokumentenorientierte_Datenbank, June 2014.
- [5] Mongo DB <http://docs.mongodb.org/manual/faq/fundamentals/>, June 2014.
- [6] Performance comparison between mysql and mongoDb <http://skowron.biz/artikel/mysql-mariadb-vs-mongodb/>, 18. 05. 2013.
- [7] D. Reissner, M. Caspar, W. Hardt, F. Strakosch, F. Debel, "Energy-efficient adaptive communication by preference-based routing and forecasting," *Multi-Conference on Systems, Signals & Devices (SSD), 2014 11th International*, vol., no., pp.1,6, 11-14 Feb. 2014.

VHDL implementation of Flight Control functions of Quadcopter and its integration in Zynq SoC (System on Chip)

Ganzorig Ulziibayar
Computer Engineering Department
Computer science faculty, TU Chemnitz
ganzorig.ulziibayar@informatik.tu-chemnitz.de

Abstract

Unmanned Aerial Vehicles (UAVs) are widely used in both industry and academic area. The Flight Control (FC) is the key function which allows stable flight in the air. Typically it is implemented in software using small microcontrollers. In order to do Mission based tasks, user requires extra add-on hardware to support such functionality. In this paper, I present a VHDL implementation of Flight Control functions of Quadcopter and its integration in Zynq SoC. This hardware implementation has several benefits over conventional software implementation. Firstly migrating Flight Control functions into hardware provides plenty of room for a Microprocessor to do other tasks such as Mission Control. This also leads no extra Microprocessor. Second, it is complete RTL (register-transfer-level) design described in vhdl, i.e., no Vendor specific macros or hard cores are used. Therefore it is easily portable to platforms from different vendors. Next, many efficient algorithms are utilized for arithmetic and trigonometric functions like Non-Restoring Square Root Algorithm, Booth Multiplier Algorithm, Cordic Algorithm. As a result, it achieves less area, higher speed. Finally providing AMBA AXI-lite interface gives easy integration in SoCs like 7 Series Zynq from Xilinx.

Keywords—Flight Control, UAV, IMU, Complementary filter, FPGA)

I. INTRODUCTION

Nowadays UAVs are becoming very popular in industry and in academic area because of its variety of applications, cost effectiveness. It is acronym of Unmanned Aerial vehicle which consists of rotors, several motion, inertial and magnetic sensors and control board which steers the rotors based on the orientation estimated from sensors. There are several kind of UAVs depending on number of rotors. One such example is a Quadcopter with 4 rotors. Each rotor produces the thrust. By applying more thrust, it is possible to adjust the yaw, roll, and pitch angles. E.g. a Quadcopter adjusts its pitch or roll by applying more thrust to one rotor and less thrust to its opposite rotor.

In General, UAV's flight architecture levels comprise of Flight Control, Navigation Control and Mission Control. First one handles the stable flight, latter one defines how it will navigate, final level allows it to do some tasks. In order to fly the UAV, one needs a controller like PID with feedback of exact orientation (pitch, roll, and yaw). This can be achieved by

inertial sensors (accelerometer, gyroscope, magnetometer) which needs to be fused together to get reliable readings of above angles.

There are many cost efficient Flight Control platforms based on microcontrollers which offers seamless flight along with extra features like "position holding, waypoints tracking etc."

In this paper, I'm focusing on Flight control. It comprises of implementing sensor acquisition, sensor fusion and PID control on Zynq Soc. Zynq is all programmable SoC which has dual core processor and PL (programmable logic) resource just like FPGA. Compared to microcontroller based platform, one can describe his/her own custom hardware on PL and write the software for controlling that hardware on the processor. Thus one can benefit from best of hardware and software. Whereas microcontroller based platform has limited number of resources. Without additional hardware, adding heavy algorithms like image processing is not feasible. Often times, such algorithms are described in hardware.

The implementations are simple and area-time efficient. It is tested on Spartan3e, Spartan6 fpga and Zynq SoC boards from Digilent. As in reference, several algorithms for multiplication, square root, arctangent are utilized.

The paper is organized as follows. Section II describes the complementary filter. Section III contains the Zynq SoC Integration. And finally section concludes my current research work.

II. COMPLEMENTARY FILTER

This filter is the simplest and easy to implement. It is used for getting a clean and stable angle estimate with the help of accelerometer, gyroscope and magnetometer. Although accelerometer alone give you angle, it is not stable and accurate enough.

Following is the simple equation for complementary filter.

$$roll_{acc} = atan2(y_{acc}, \sqrt{x_{acc}^2 + z_{acc}^2})$$

$$pitch_{acc} = atan2(-x_{acc}, \sqrt{y_{acc}^2 + z_{acc}^2})$$

$$G_x = x_{gyro} * t_{period}$$

$$G_y = y_{gyro} * t_{period}$$

$$roll_{cf} = 0.98 * (roll_{cf} + G_x) + 0.02 * roll_{acc}$$

$pitch_{cf} = 0.98 * (pitch_{cf} + G_y) + 0.02 * pitch_{acc}$
 $roll_{cf}$ – Roll angle output, $pitch_{cf}$ - Pitch angle output
 G_x –Delta angle x axis, G_y - Delta angle y axis
 x_{gyro} – Angular rate x axis
 y_{gyro} – Angular rate y axis
 t_{period} – Sample period of sensor
 $roll_{acc}$ - Roll angle calculated using accelerometer
 $pitch_{acc}$ - Pitch angle calculated using accelerometer

Exact behavior of these equations are implemented on hardware. As for calculating arctangent, instead of Lookup table, cordic algorithm was used [5]. It is a method of calculating a math function using much simpler math operations in a loop called Binary search. Following rotation equation is the basis of finding arctangent.

$$X_{new} = X * \cos \alpha - Y * \sin \alpha$$

$$Y_{new} = Y * \cos \alpha + X * \sin \alpha$$

It can be simplified to:

$$X'_{new} = X - Y * \tan \alpha$$

$$Y'_{new} = Y + X * \tan \alpha$$

The idea now is from the given X, Y point, we will rotate clockwise and counterclockwise based on the sign of Y'_{new} until it is close or equal to zero. Rotating angles are already pre-computed. In each rotation, this angle should be added on or subtracted from the current angle.

Below shows the C implementation.

```
int[] table = {45, 26.565, 14.036, 7.125, 3.576, 1.79, 0.895, 0.448, 0.224, 0.112, 0.056, 0.028, 0.014, 0.007, 0.003};
```

```
for (i=0; i<15;i++)
{
    if (y >=0)
    {
        x_new = x + (y>>i);
        y_new = y - (x>>i);
        SumAngle = SumAngle + table[i];
    }
    else
    {
        x_new = x - (y>>i);
        y_new = y + (x>>i);
        SumAngle = SumAngle - table[i];
    }
    x = x_new;
    y = y_new;
}
```

Reason for choosing angles like 45 and 26.565 is $\arctan(45) = 1$, $\arctan(26.565) = 0.5$ which requires simple right shift instead of multiplication. As it shown in above, only addition, subtraction, shift operations are used. But the shift operation is variable controlled. It can be achieved by barrel shifter. But I chose a design with 15 stage pipeline. Each stage is described as in Fig3. Compared to the barrel shifter, it has shorter data-

path, resource usage is almost identical and it can evaluate angle at each clock cycle with cost of 15 clock cycles latency.

For multiplication, booth algorithm [4] was used. It multiplies two signed integers with same bit width. For example multiplying 0011*1110 will be 1111 1010. See Table 1.

A	B	OP	
0000 00110	1110	10	Subtract and shift right
1110			
0001 00110			
0001 00011	1110	11	Shift right
0000 10001	1110	01	Add and shift right
1110			
1110 10001			
1111 01000	1110	00	Shift right
1111 10100			Result (upper 8 bit)

Table 1. An example of booth algorithm

First we concatenate bitwidth '0's on the MSB side and one '0' on the LSB side of the multiplicand and put it in A register. Depending the rightmost 2 bits, above operation will be executed. After bit width times iteration, upper 2*bit width is the result.

In hardware, It is realized as two multiplexer, one adder, one shift register, one two's complement, XOR logic and a small (FSM) for indicating the result is ready. See Fig 2.

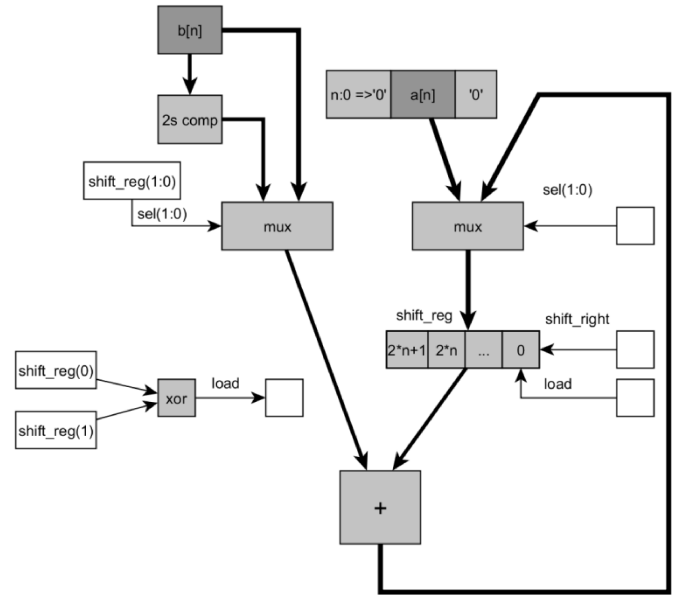

Figure 2. Hardware realization of booth algorithm

As can be seen above, it is very simple and uses very less resource. Thus it is area efficient, but it compromises little on the speed.

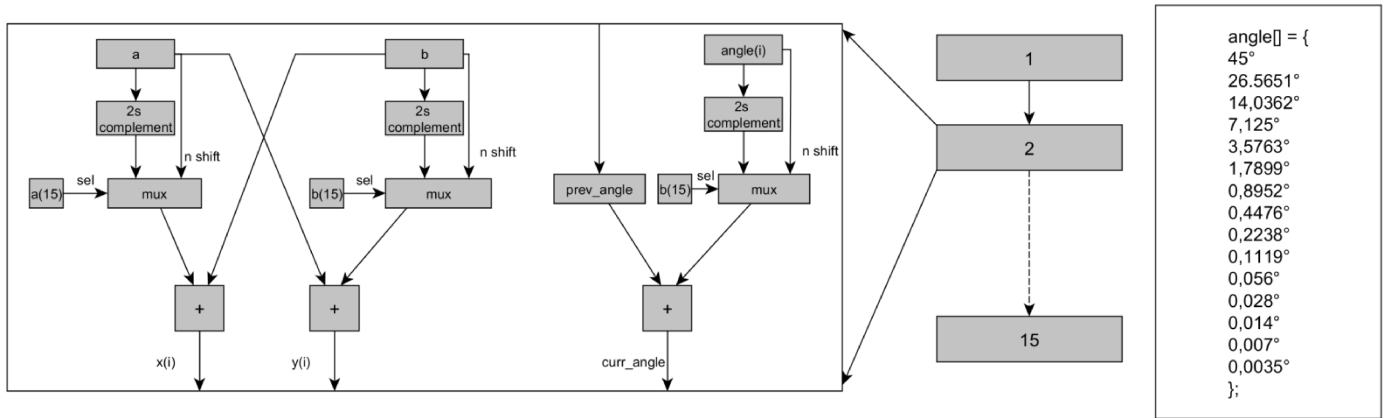

Figure 3. Pipeline stage of CORDIC algorithm

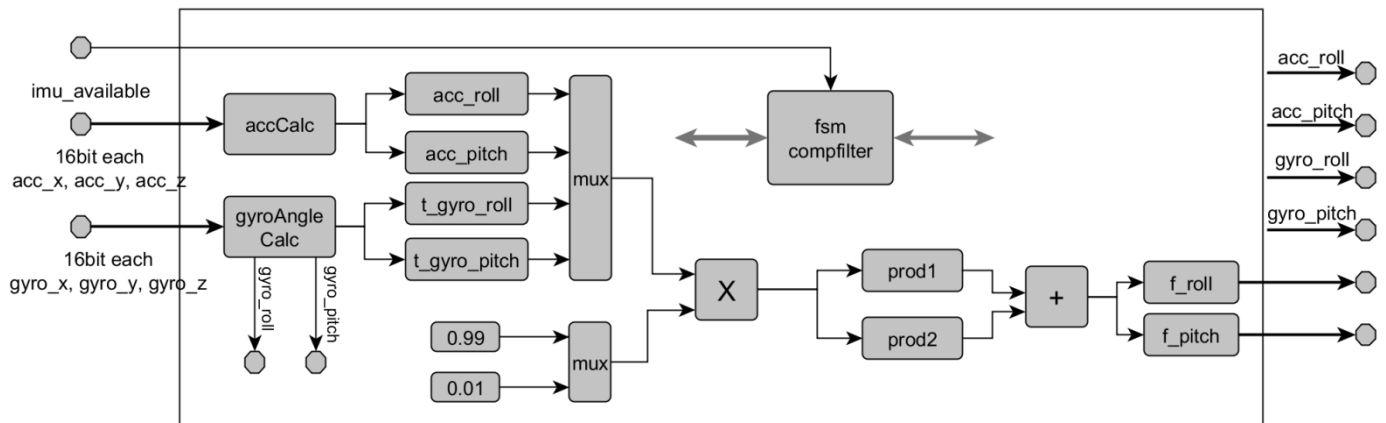

Figure 4. Complementary filter in block diagrams

As for square root operation, "new non-restoring square root algorithm" of "Yamin Li and Wanming Chu from The University of Aizu" is used. It also uses simple shift, addition operations. Please refer to [3] for more detail.

Using all these operations, following design Fig.4 is created to calculate the roll and pitch angles. From this component, three different roll, pitch angles are calculated from an accelerometer, a gyroscope, and the complementary filter.

III. ZYNQ SOC INTEGRATION

In this section, I will explain how the flight control function is integrated in the Zynq. As mentioned above, Zynq SoC contains both programmable logic (PL), Dual Core Processor. The Custom hardware can be created at the PL and can be connected to Processor via AMBA interface. Figure 6 depicts the entire system of Quadcopter.

Flight control functions are implemented on the PL. On the PL, there is AMBA AXI-lite interface which allows access from the PS (Processing system). There are several different sensors interfaced through i2c, spi, pwm. Each of these is described as ip cores in the hardware. From the remote control, ppm sum signal is received which then scaled to relative angles that we want to steer via PID controller. Currently, I'm working on the PID tuning, and the next

planned works are evaluating performance of the system against the Microcontroller based systems, executing tasks in the mission control level. The result of these works will be on the next publications.

Just for demonstration, below graph (Fig.5) shows the roll angle calculated from Complementary filter component. It runs on the Zynq 7010 AP SoC based Zybo board from Digilent. All output values are received on PC via Serial port. Data rate of sensors is 800Hz.

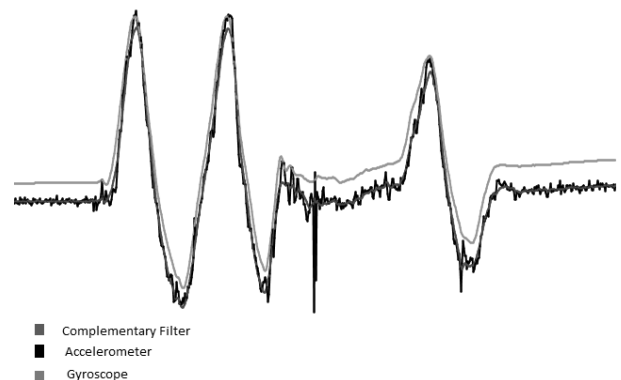

Figure 5. Complementary filter output

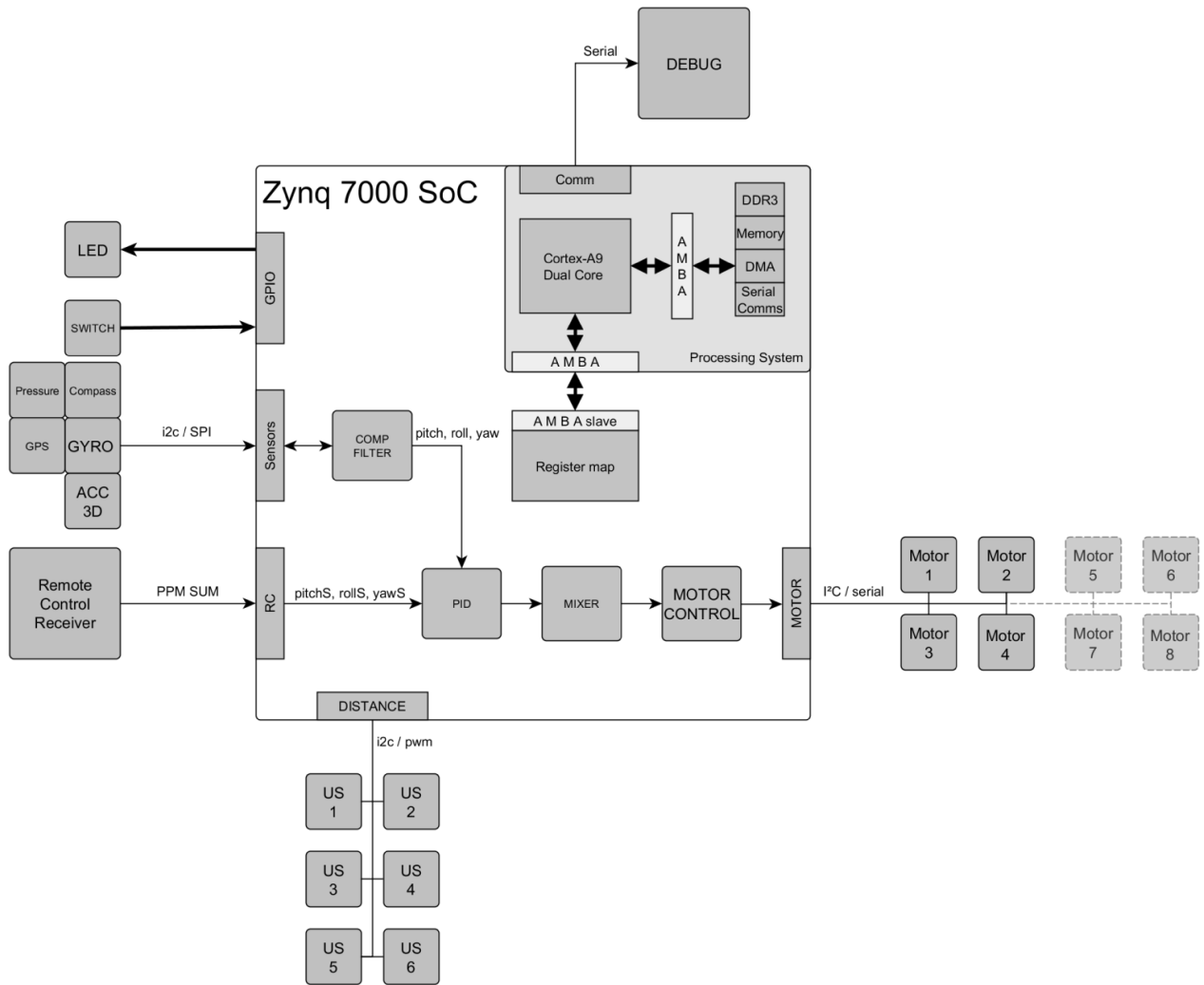

Figure 6. System diagram of Quadcopter

Gyroscope is good at short-term angle estimation. But in long term, it drifts away. As for accelerometer, it is good at long-term estimation. It can be said that by combining these two sensors, resulting angle value is more accurate and stable.

IV. CONCLUSION

A VHDL implementation of flight control functions of quadcopter and its integration on Zynq SoC are presented in this paper. It consists of several different modules. Each of these modules are simulated, implemented and tested on different development platforms.

This hardware implementation is relatively simple and easily integrated to any platform due to the independence to Vendor specific macros. Several very efficient square root, arctangent, multiplication algorithms are used. Thus it achieves high speed at low area cost. Algorithms and implementations are presented in block diagrams which may be sufficient for readers from hardware background to implement such modules using their own code.

REFERENCES

- [1] Steve Kilts, "ADVANCED FPGA DESIGN", Architecture, Implementation, and Optimization, 2007
- [2] Pong P.Chu, "RTL HARDWARE DESIGN USING VHDL", Coding for Efficiency, Portability, and Scalability, 2006
- [3] Yamin Li and Wanming Chu, "A New Non-Restoring Square Root Algorithm and Its VLSI Implementations", 1996
- [4] Booth's multiplication algorithm, http://en.wikipedia.org/wiki/Booth's_multiplication_algorithm
- [5] CORDIC algorithm, <http://en.wikipedia.org/wiki/CORDIC>
- [6] AXI Reference Guide, UG761 January 18, 2012 http://www.xilinx.com/support/documentation/ip_documentation/ug761_axi_reference_guide.pdf
- [7] Zynq-7000 All Programmable SoC: Concepts, Tools, and Techniques, http://www.xilinx.com/support/documentation/sw_manuals/xilinx14_3/ug873-zynq-ctt.pdf
- [8] Zynq-7000 All Programmable SoC Technical Reference, http://www.xilinx.com/support/documentation/user_guides/ug585-Zynq-7000-TRM.pdf
- [9] Reference Designs/Tutorials of Zedboard, <http://www.zedboard.org>
- [10] Development with Zynq - Programmable Logic projects with Vivado, <http://blog.fakultaet-technik.de/development-with-zynq-part-1/>

Analysis Algorithm for Interference Patterns with Random Phase Shifts

D.S. Haydukov, V.I. Guzhov, S.P. Ilinykh
 Computer Science Department
 Novosibirsk State Technical University
 Novosibirsk, Russia
 dmitriyhaydukov@gmail.com

Abstract — analysis algorithms for interference patterns based on the phase shifts are widely used in creation of interference measuring systems. The phase-shifting method is based on obtaining interference patterns when the phase of a reference wave is changed to known values. An accuracy of existing analysis algorithms depends on a setting accuracy of inserted phase shifts values. However, it is difficult to determine an exact value of the phase shift in practice because of errors of devices performing a phase shift. A new analysis algorithm for interference patterns is considered in this paper. The algorithm uses three interference patterns with arbitrary phase shifts in order to calculate a phase.

Keywords — *interferometry; interference measuring system; interference patterns analysis*

I. INTRODUCTION

A non-contact surface relief measurement based on an interference principle is a modern research area. Interference patterns captured during a measurement process contain a large amount of information that must be processed and decoded to obtain qualitative and quantitative assessments. This requires a presence of according computer systems and software to obtain, transform and process information. Software is used to decode interference patterns and present results in an appropriate form.

Interference measurement systems consist of an interferometer, a camera that is used to capture interference patterns, and a data processing system. An operating principle of an interferometer can be described as follows. An electromagnetic radiation beam from a laser is spatially divided in two coherent beams using a beam-splitter. The former is reflected from an object to be measured, the latter is reflected from a reference mirror. Each of the beams goes through different optical paths and returns to a screen, creating an interference pattern (interferogram). Figure 1 shows a simplified scheme of the Twyman-Green interferometer.

Then the captured interference patterns are used to restore a surface of an object to be measured, which is a task of a phase restoration for interference patterns.

From a mathematical point of view the task of a phase restoration is a determining of phase difference values of

interfering wave fronts using a measured intensity of the captured interference patterns.

Analysis methods for interference patterns based on phase shifts are widely used for a construction of interference measurement systems [1]. A phase shift method is based on a capturing of several interference patterns when a reference wave phase is changing to known values.

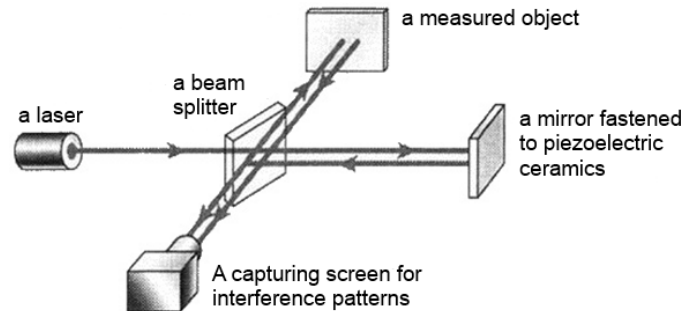

Fig. 1. The Twyman-Green interferometer scheme.

The interferogram's intensity at a point (x,y) with different phase shifts δ_i is

$$I_i(x, y) = I_0(x, y) [1 + V(x, y) \cos(\varphi(x, y) + \delta_i)], \quad (1)$$

where $I_0(x,y)$ — an average brightness, $V(x,y)$ — an interference pattern visibility, $\varphi(x,y)$ — a phase difference between interfering wavefronts, $i=1,2,\dots, m$, m — a phase shifts number.

There are formulas to determine the phase difference. If phase shifts are identical in the range $0...2\pi$ the phase difference φ can be calculated as [2]

$$\varphi = \arctg \left[\frac{\left(\sum_{i=1}^n I_i \sin \delta_i \right)}{\left(\sum_{i=1}^n I_i \cos \delta_i \right)} \right] \quad (2)$$

The phase difference can be calculated using three arbitrary phase shifts:

$$\varphi = \arctg \frac{(I_2 - I_3)\sin(\delta_1) + (I_3 - I_1)\sin(\delta_2) + (I_1 - I_2)\sin(\delta_3)}{(I_3 - I_2)\cos(\delta_1) + (I_1 - I_3)\cos(\delta_2) + (I_2 - I_1)\cos(\delta_3)} \quad (3)$$

An accuracy of existing analysis algorithms depends on a setting accuracy of introduced phase shifts. However, in practice it is difficult to determine an exact phase shifts values because of phase shift devices' errors.

This paper is dedicated to an analysis algorithm for interference patterns with three random phase shifts. A gist of the algorithm is to transform a trajectory of interference signals (intensities) with random phase shifts to a trajectory of signals whose phase shifts are exactly known.

II. ALGORITHM DESCRIPTION

Suppose there are three interference patterns with phase shifts $\delta_1, \delta_2, \delta_3$ (figure 2).

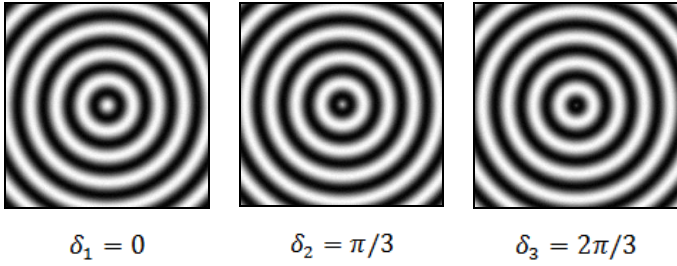

Fig. 2. Interference patterns with different phase shifts.

In the first step of the algorithm intensities vectors are created for each pixel of an interference pattern. These intensities vectors contain an intensity value in a particular pixel of an interference pattern with different phase shifts. Let $I_1(x,y)$ — an intensity value at pixel (x,y) on the first interference pattern, $I_2(x,y)$ — an intensity value at pixel (x,y) on the second interference pattern, $I_3(x,y)$ — an intensity value at pixel (x,y) on the third interference pattern. Then the intensities vector at pixel (x,y) on the interference pattern is $\mathbf{I}(x,y) = [I_1(x,y); I_2(x,y); I_3(x,y)]$.

Then orthogonal vectors are calculated for each intensities vector. Orthogonal vector can be calculated using a matrix equation

$$\mathbf{I}^\perp = \mathbf{M} \cdot \mathbf{I}. \quad (4)$$

A transformation matrix M must satisfy the following requirements:

$$|M| = 0, M \cdot [1 \dots 1]^T = 0 \quad (5)$$

Calculated orthogonal vectors will have the same dimension as the intensities vector, i.e. contain three components. Figure 3 shows a trajectory of orthogonal vectors in an intensities space. Coordinates of each point in figure 3 are elements of the corresponding orthogonal vector. A shape and

a location of a points cloud depend on phase shifts in interference patterns.

In view of orthogonal vectors properties all points in the intensities space will be located in the same plane. This allows us to reduce a problem dimension. The resulting points cloud is rotated so that it would be parallel to a coordinate plane XY (figure 4). Then the points cloud is projected to a coordinate plane XY . After that points on the coordinate plane XY are approximated by an ellipse (a second-order curve) using an algorithm described in [4]. A second-order curve is determined by a following equation [3]:

$$a_{11}x^2 + a_{22}y^2 + 2a_{12}xy + 2a_{13}x + 2a_{23}y + a_{33} = 0 \quad (6)$$

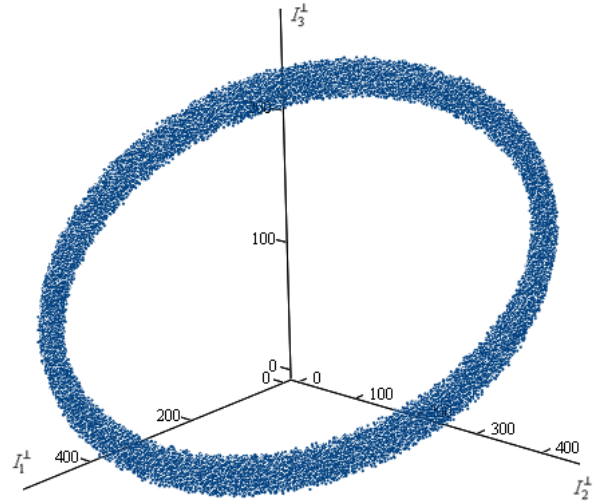

Fig. 3. A trajectory of orthogonal vectors in a space of intensities.

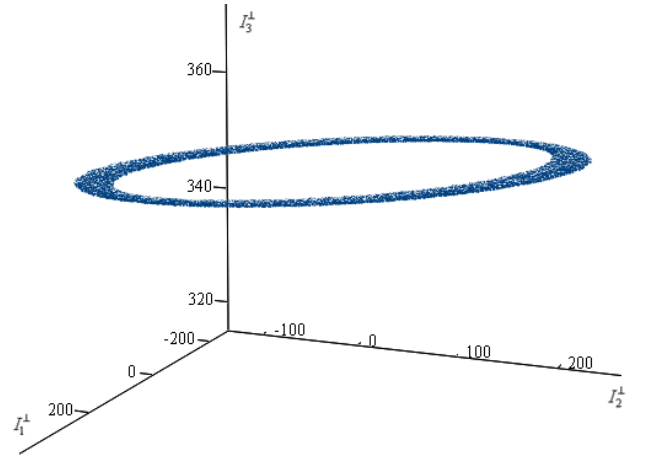

Fig. 4. An orthogonal vectors trajectory that is parallel to a coordinate plane.

The approximation algorithm uses an approximation criterion as in a least squares method, but the algorithm takes into account certain restrictions for coefficients of a second-order curve equation which represents exactly an ellipse. Figure 5 shows a result of an approximation.

The next step — inscribe an ellipse into a cylinder. For that it is necessary to determine a cylinder guideline. Suppose a — an ellipse's semi-major axis, b — an ellipse's semi-minor axis. Axes lengths of the ellipse can be determined from an equation of a second-order curve as follows. At first calculate characteristic equation roots of a second-order curve:

$$\begin{vmatrix} a_{11} - \lambda & a_{12} \\ a_{12} & a_{22} - \lambda \end{vmatrix} = 0 \quad (7)$$

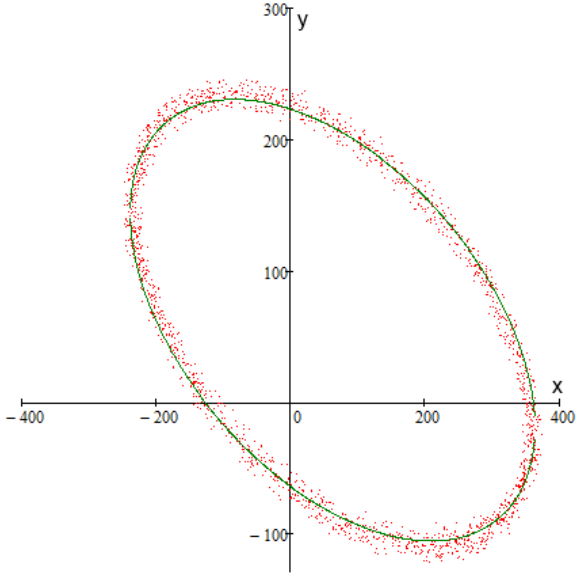

Fig. 5. A trajectory approximation using an ellipse.

Roots λ_1 and λ_2 of this equation are eigenvalues of a real symmetric matrix:

$$\begin{bmatrix} a_{11} & a_{12} \\ a_{12} & a_{22} \end{bmatrix} \quad (8)$$

Then axes lengths of an ellipse can be determined as follows. When $\lambda_1 > \lambda_2$:

$$a = \sqrt{(-1/\lambda_2) \cdot (A/D)}, b = \sqrt{(-1/\lambda_1) \cdot (A/D)} \quad (9)$$

where A and D are invariants of a second-order curve calculated using following formulas [3]:

$$D = \begin{vmatrix} a_{11} & a_{12} \\ a_{12} & a_{22} \end{vmatrix}, A = \begin{vmatrix} a_{11} & a_{12} & a_{13} \\ a_{12} & a_{22} & a_{23} \\ a_{13} & a_{23} & a_{33} \end{vmatrix}. \quad (10)$$

When $\lambda_2 > \lambda_1$:

$$a = \sqrt{(-1/\lambda_1) \cdot (A/D)}, b = \sqrt{(-1/\lambda_2) \cdot (A/D)} \quad (11)$$

A guideline \mathbf{L} of a cylinder into which an ellipse will be inscribed has a following form:

$$\mathbf{L} = \begin{bmatrix} \cos(\Omega) \\ \sin(\Omega) \\ b/a \end{bmatrix} \quad (12)$$

where Ω — an angle between a positive direction of the axis X and each of the two main lines of a second-order curve calculated using a formula [3]:

$$\Omega = \frac{1}{2} \arctg \frac{2a_{12}}{a_{11} - a_{22}} \quad (13)$$

Then the intensities trajectory can be transformed to a circular trajectory using the guideline of a cylinder into which an ellipse is inscribed. Each point of the intensities trajectory is projected along the cylinder guideline on a plane that is parallel to a cylinder base. A transformation is carried out as follows. Let $P(x, y, z)$ — an ellipse point in the space for the original intensities trajectory. Then a new point G on a circular trajectory is calculated using a formula:

$$G = P - (\mathbf{L} \cdot P) \cdot \mathbf{L} \quad (14)$$

Figure 6 shows a result of a transformation to a circular trajectory. All points on the circular trajectory will be located in the same plane which is parallel to the cylinder base.

The next step — rotate the circular trajectory in such a manner that a normal direction of a plane in which points of the circular trajectory are located coincides with direction of a vector $\mathbf{E} = [1; 1; 1]$. To perform this operation it is necessary to find a rotation matrix to rotate a plane normal of the circular trajectory to a vector \mathbf{E} .

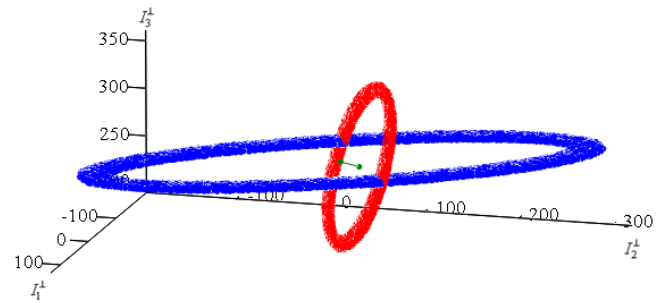

Fig. 6. A transform to a circular trajectory (a projection along a cylinder guideline)

This rotation matrix can be found as follows. Let \mathbf{T} — vector that is rotated to a vector \mathbf{P} . At first calculate an angle β between vectors \mathbf{T} and \mathbf{P} using following formula

$$\beta = \arccos \frac{\mathbf{T} \cdot \mathbf{P}}{|\mathbf{T}| \cdot |\mathbf{P}|}. \quad (15)$$

Calculate cross product of these vectors

$$\mathbf{V} = \mathbf{T} \times \mathbf{P}. \quad (16)$$

Then normalize the vector \mathbf{V} :

$$R = \frac{\mathbf{V}}{|\mathbf{V}|} \quad (17)$$

Create a skew-symmetric matrix A :

$$A = \begin{bmatrix} 0 & -R_z & R_y \\ R_z & 0 & -R_x \\ -R_y & R_x & 0 \end{bmatrix} \quad (18)$$

Then a required rotation matrix S can be found using an exponential map (Rodrigues formula):

$$S = J + \sin(\beta) \cdot A + (1 - \cos(\beta)) \cdot A^2 \quad (19)$$

where J — an identity matrix of size 3×3 .

Further each point of the circular trajectory is rotated using the rotation matrix S . Figure 7 shows a result of this transformation.

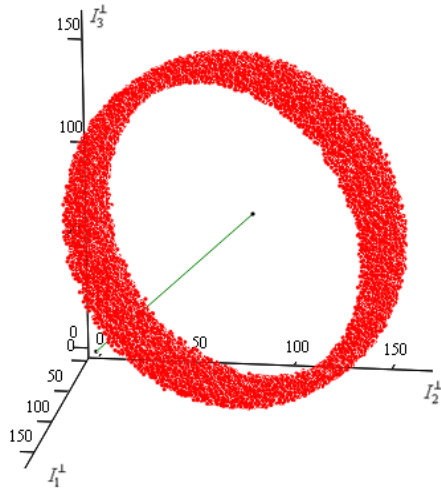

Fig. 7. A trajectory rotation to a vector $\mathbf{E}=[1;1;1]$.

After a transformation to a circular trajectory the phase difference of interfering wave fronts can be found using a well-known decoding formula with phase shifts values $\delta_1=0$, $\delta_2=2\pi/3$, $\delta_3=4\pi/3$.

III. MODELING EXPERIMENT

Interference patterns 300×300 pixels were simulated to test the proposed analysis algorithm. Figure 8 shows modeling interference patterns with random phase shifts δ_1 , δ_2 , δ_3 . Figure 9 shows a phase distribution for entire field corresponding to model interference patterns.

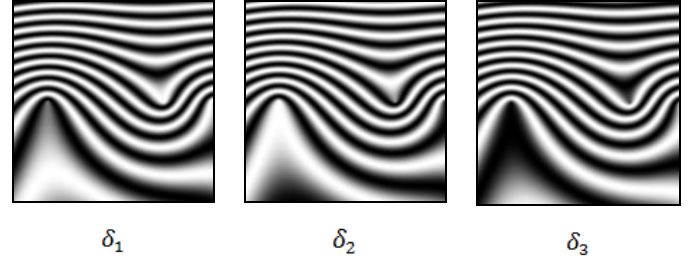

Fig. 8. Modeling interference patterns with random phase shifts.

Figure 10 shows a real phase and a calculated phase using the proposed algorithm for a particular row of an image. Figure 11 shows a calculating phase error.

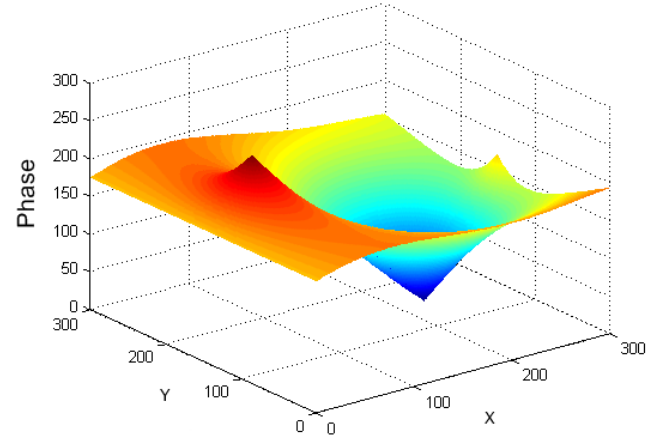

Fig. 9. A phase distribution for an entire field.

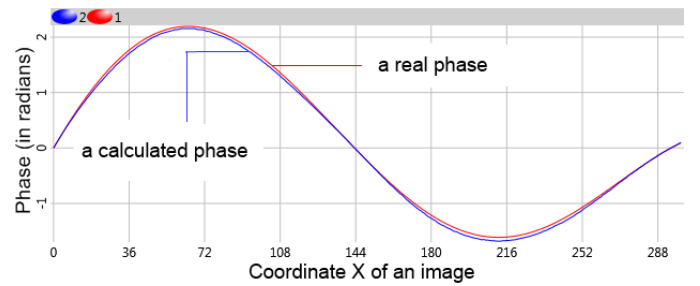

Fig. 10. A real phase and a calculated phase for a particular row.

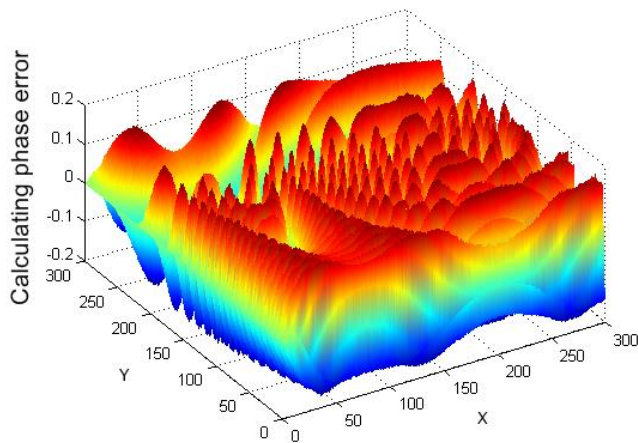

Fig. 11. An error of phase calculating at each point in the field.

RMSE of a phase calculating using the proposed decoding algorithm is 0.033 radians.

IV. CONCLUSION

The proposed algorithm allows calculate a phase using only three interference patterns with random phase shifts. An accuracy of the algorithm is comparable with an accuracy of

conventional analysis algorithms which require exact values of phase shifts. Results of a model experiment demonstrate a high accuracy of the algorithm. Unknown random phase shifts can be introduced by vibrations of a measurement system during an experiment and can be used for an analysis of interference patterns.

REFERENCES

- [1] Creath K. "Phase-Measurement Interferometry Techniques," in Progress in Optics. Vol. XXVI, E. Wolf, Ed., Elsevier Science Publishers, Amsterdam. – 1988. – pp. 349- 393.
- [2] Bruning J.H., Herriot D.R., Gallagher J.E., Rosenfeld D.P., White A.D., Brangaccio D.J. Digital wavefront measuring interferometer for testing optical surfaces and lenses// Applied Optics.- 1974.- V.13.- No.11.- P.2693-2703.
- [3] Korn G.A., Korn T.M. Mathematical handbook for scientists and engineers. – Mineola, New York: Dover Publications, Inc., 2000. 1130 p.
- [4] Fitzgibbon, A. W., Pilu, M and Fischer, R. B.: Direct least squares fitting of ellipses. Technical Report DAIRP-794, Department of Artificial Intelligence, The University of Edinburgh, January 1996.- pp. 476-480

Development of automatic stabilization system of two-wheeled platform in a vertical position

Ivoilov A.Y., Zhmud V.A., Trubin V.G.

Department of Automation

NSTU

Novosibirsk, Russia

iaul3hv@mail.ru

Abstract: this paper addresses issues related to the development of automatic stabilization and, in particular, the stabilization system in the vertical position of the object type «inverted pendulum». This article describes the stages of development of the system: the creation of an electrical circuit, the development of control software modules and the obtainment of a mathematical model of the system. For the operation of the automatic stabilization is necessary to measure the value of the parameter to be stabilized. In addition to the setting you often need to receive details of the derivative of this parameter. Measured parameter usually contains interference that makes it difficult to derivative. The article discusses issues related to filtering the signal, in particular, the use of differentiating filters in order to obtain the derivative signal. A separate section is devoted to the work on the use of visual display products, such as liquid crystal displays, in systems operating in real time.

Keywords – automatic control system; inverted pendulum; accelerometer; servomotor; microcontroller; DISCOVERY; differential filter; LCD

I. INTRODUCTION

This article describes the development of automatic stabilization system two-wheeled platform in a vertical position. The control object of this system is the platform on which the control board is placed. On the board placed sensors, driving circuits and the processing unit based on the microcontroller. By platform rigidly attached motor stator. The wheels are mounted on the shafts of motor. Exterior view of platform is shown in Figure 1.

Controlling parameters of the system are the platform angle relative to the vertical and the angle of rotation of the wheel relative to the initial position. From a mathematical point of view control object is a kind of object "inverted pendulum". The problem of stabilization of this object is one of the classic problems in the theory of automatic control and is quite common in the technology. Equations of the object described, for example, the behavior of the rocket at the start or multi-antenna. The difference between the developing system and the classical inverse pendulum is that the suspension point of the pendulum is secured to the wheel.

II. STRUCTURE OF SYSTEM

The development of system includes: development of platform circuit, development of component controlling software units and design of stabilization algorithm of system. Block diagram of the system is shown in Figure 2. The system

includes the following components: micro controller unit, motor driving circuits, servomotors, accelerometer, liquid-crystal display and Bluetooth module.

Accelerometer used in the system is ADXL-335 [3]. The system includes communication module uses Universal Asynchronous Receiver Transmitter interface (UART). This module is used for debugging the system and setting mode. Bluetooth module (e.g. HC05) for wireless communication or USB-TTL converter (e.g. PL2303) for wire communication can be connected to micro controller using UART interface. The LCD NOKIA 5110 [4] is placed on the platform for displaying current system status. The system state data can be displayed as text or graphics information by using this LCD.

The control program is designed in such a way that each unit in the system can be controlled independently from other units. This approach to programming allows the flexibility to develop the system, retaining the ability to add modules to the system. In such case the important requirement to development of software modules is the requirement for performance as it is necessary to ensure the performance of all components in order to ensure the performance of the entire system.

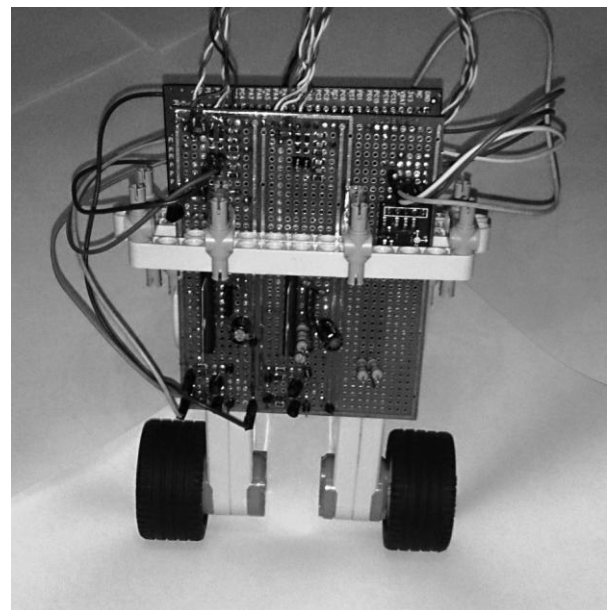

Fig.1 Exterior view of platform

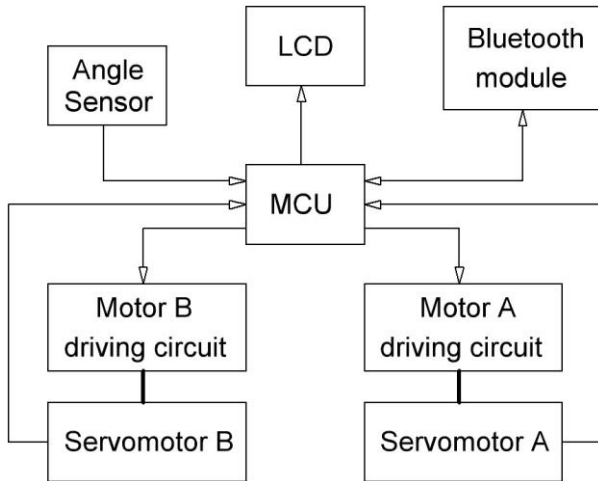

Fig.2 Diagram block of the system

Besides control software units control the program includes modules which directly implement the algorithm to stabilize the platform. Such modules are modules of data acquisition from sensors, filtering data, digital differentiation and also unit that implements calculation of control action. Key issues related to the implementation of software modules are considered further.

III. ACCELEROMETER

The system uses an accelerometer ADXL-335. This circuit has three analog channels. Signal value of each channel corresponds to the projection of acceleration on one of the axes. Accelerometer has following parameters:

- Number of sensing axes: 3
- Supply current: 350 μ A
- Measurement range: $\pm 3,6$ g
- Nonlinearity: $\pm 0,3$ %
- Sensitivity: 400 mV/g
- Operating voltage: 3V

Accelerometer measures the projections of resultant acceleration on axes. If only the force of gravity acts upon the accelerometer than we can calculate tangent of accelerometer angle relative to a vertical direction by using values of acceleration projections on axes:

$$tg\varphi = \frac{F_x}{F_y}$$

This principle is illustrated in Figure 3. Further the angle can be restored by value of tangent by using one of following methods.

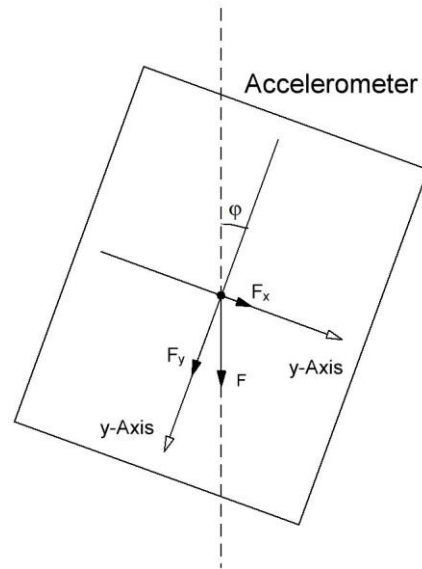

Fig.3 The scheme for determining the tilt angle via the accelerometer

For applications, in which the tilt angle varies in a small range, the following approximation can be used:

$$\frac{F_x}{F_y} = tg\varphi \cong \varphi$$

It is possible to restore the angle with an accuracy of 1% in a range from -20 to +20 degrees by using this approximation. And the accuracy of 5% is in range from -30 to +30 degrees. But, if it is required to operate over a wider range of angle, this method is not suitable for determining the angle. In this case one of the following methods can be used.

The first way is a tabular method. The angles are associated with values of the ratio of the projection. This information is stored in the memory of microcontroller in the data array form. It is expedient to store the angle data array in a range from 0 to 45 degrees to reduce the amount of microcontroller memory. If angle is in a range from 45 to 90 degrees than inverse ratio is calculated and angle is restored by using formula:

$$\varphi \approx \frac{\pi}{2} - \frac{F_y}{F_x}$$

For angles which correspond to others quadrants values are restored by corresponding trigonometric formulas.

The binary search algorithm can be used to determine the closest to measured value in array. The application of this algorithm allows improve performance. In such case the number of steps required to determine the angle is fixed and equal:

$$n = \log_2 N$$

where N is a number of values in the table. This method saves computing resource of microcontroller. But it requires larger amount of memory. It may be problematical for some systems.

If the memory is full angle can be calculated by using a Taylor series expansion of a tangent function. To calculate an angle we can use the first few terms of the series:

$$tg\varphi = \varphi + \frac{1}{3}\varphi^3 + \frac{2}{15}\varphi^5 + \dots$$

This method requires more computing resource, but it does not require a large amount of memory. The application of a particular method depends on the requirement of accuracy of the angle determination, the range of measurement, computing resource of microcontroller and amount of a memory.

Build-in microcontroller ADC is used to measure the accelerometer data. Its resolution is 12 bits. Data received by microcontroller transmitted on PC in angle determining module debugging process by using UART interface. USB-TTL converter is used for this purpose. The signal from accelerometer contains significant high-frequency interference. Graph of dependence of angle on time in this case is shown on Figure 4. As it can be seen, the range of angle values is about two degrees. It is necessary to use data filtering to reduce a range of angle values.

To operate the system it is necessary not only tilt angle, but its derivate. Therefore it is necessary to restore both of these parameters. For this purpose the software module which implements a derivative filter is developed. Filtering signal and its derivate can be obtained by using this filter. The operation of integration is replaced by summation operation in algorithm which implements the filter. The block diagram of filter is shown on Figure 5.

It is necessary additionally to filter a derivate of a signal to reduce of a high-frequency interference of derivate. The block diagram of derivate filter is shown on Figure 5. The results of a signal filtering are shown on Figures 6 and 7. The graph of original and filtering tilt angle is shown on Figure 5. The graph of a derivate of it is shown on Figure 6.

The disadvantage of this filtering method is delay of a filtering signal as compared with original. The value of this delay is the larger, the stronger a single smoothing. It is necessary to calculate the filter parameters in such a way that filter process proceeds on the order faster processes in a control object.

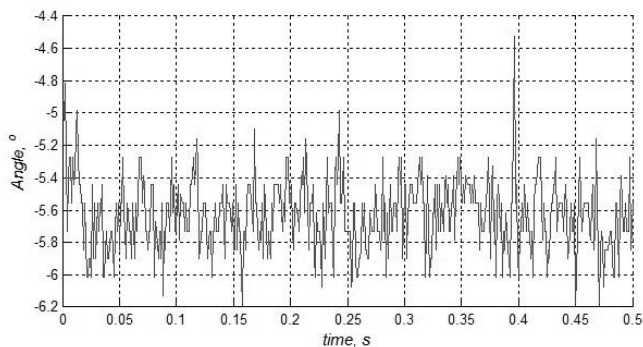

Fig.4 Graph of dependence of angle on time.

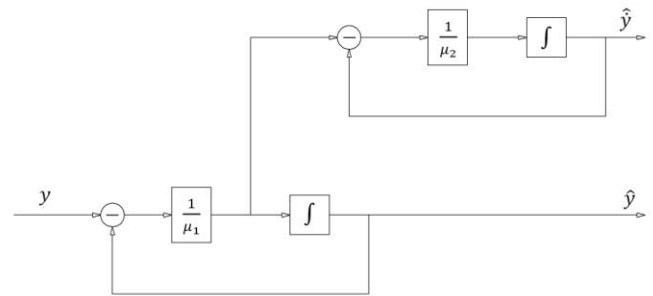

Fig.5 Block diagram of the differentiating filter. y – input signal, \hat{y} – estimate of input signal, \dot{y} – estimate of the derivative of the input signal.

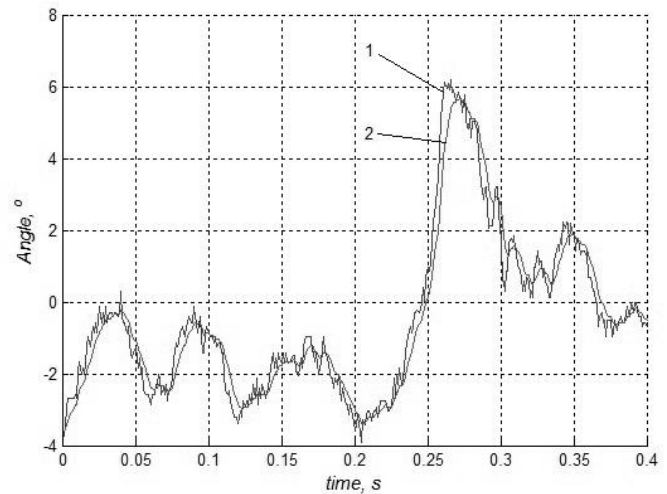

Fig.6 Filtering result. 1 – an original signal, 2 – a filtering signal.

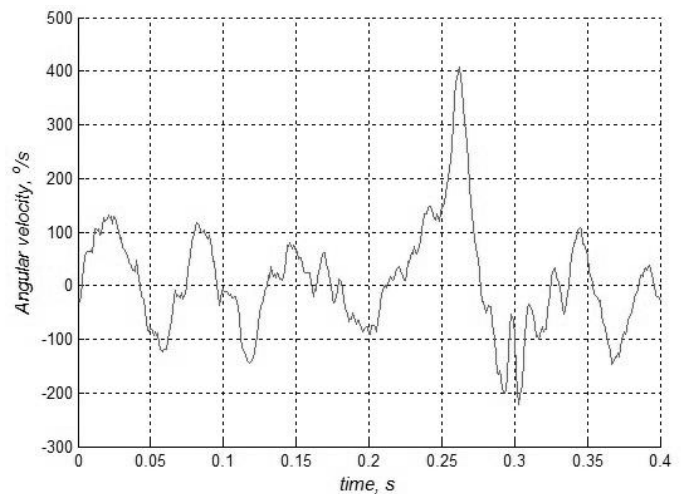

Fig.7 Filtering result. Derivative of the original signal

IV. DRIVING OF SERVO MOTORS

NXT Lego Mindstorm Servomotors are an actuator of the system. Encoder is integrated in the servomotors. Its resolution is one degree. One of the most common methods of motors voltage driving is pulse weight modulation, or PWM. Rectangular constant frequency pulses are applied on the input of motor. But their duty cycle is different. If the pulse

frequency is high the motor's windings smooth the voltage which is equal to DC voltage of certain value. There are two methods of motor driving by PWM. The signal diagram for them is shown on Figure 8.

In the first case zero voltage is applied on the first input of motor and PWM signal to the second. In this case when the high level of voltage is in the first input a motor is accelerates. In others times a motor is in the braking inertia mode.

In the second case high level of voltage is applied on the first input of motor and PWM signal to the second. In this case in the times when the high level of voltage is in the first input and zero voltage is in the second input a motor is accelerates. In others times a motor is in the regenerative braking mode.

When the first driving method is used the rotating speed of motor nonlinearly depends on the input voltage. If the second driving method is used the rotating speed of motor linearly depends on voltage, but there is significantly larger current in the windings than the first method uses. It must be taken into account that the heat load on the motor will be significantly higher if the second driving method is used.

Build-in microcontroller timer is used for driving the motors. This timer has four independent channels of control. The channels can be configured to the PWM generation mode. Modulated voltage is applied on the motors via special voltage driver chips.

The encoder data is fixed by registration of edges of a signal which encoder provides. Each edge corresponds to rotation of engine rotor one degree. The same timer is used for registration of edges of a signal. To obtain the data of rotating speed of a motor we use filter, similar to that used to estimate the derivative of the tilt angle of the platform by using data from accelerometer.

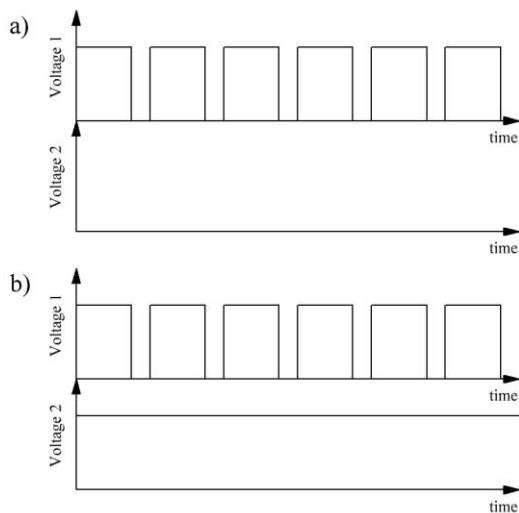

Fig.8 Methods for controlling the level of voltage: a) is a braking inertia mode, b) is a regenerative braking mode.

The math model of the motor must be obtained to operate the motor in accordance with the control algorithm of system. Approximately the behavior of the DC motor is described by the following equations:

$$\begin{aligned}
 J\dot{\omega} &= M - M_1; \\
 M &= c\Phi I; \\
 U - E &= IR; \\
 E &= c\Phi\omega; \\
 \frac{c\Phi}{R}U &= J\dot{\omega} + \frac{(c\Phi)^2}{R}\omega + M_1
 \end{aligned} \tag{1}$$

where J – moment of inertia of shaft

M – motor torque

M_1 – load torque

c – motor constructive factor

Φ – magnetic flux

R – armature winding resistance

E – counter EMF

In the idle mode of motor when U_0 voltage is applied in the input of motor the following function is the solution of the differential equation (1).

$$\omega(t) = U_0 K \left(1 - e^{-\frac{t}{T}}\right) \tag{2}$$

$$K = \frac{1}{c\Phi}, T = \frac{JR}{(c\Phi)^2}$$

If we integrate this equation on the interval from 0 to t , we obtain an expression for the angle of rotation of the motor rotor:

$$\varphi(t) = \int_0^t \omega(t) dt = U_0 K (t - T) + U_0 K T e^{-\frac{t}{T}} \tag{3}$$

As can be seen from the equation (3), with time the angle of rotation approaches the line is described by the equation:

$$\bar{\varphi}(t) = U_0 K (t - T) \tag{4}$$

To obtain a math model of the motor the angle of rotation of the rotor at a voltage $U = 4.5$ V was measured. Point on the linear portion of the graph was approximated by a straight line from the coefficients of which were determined parameters of the model:

$$K = 1.83 \frac{V \cdot s}{rad}; T = 0.061 s;$$

To check the system was simulated with the obtained values of the parameters. Figure 9 shows the results of the simulation system and the data obtained by measuring the angle of rotation of the motor. Figure 10 shows similar data for a rotor speed of the motor.

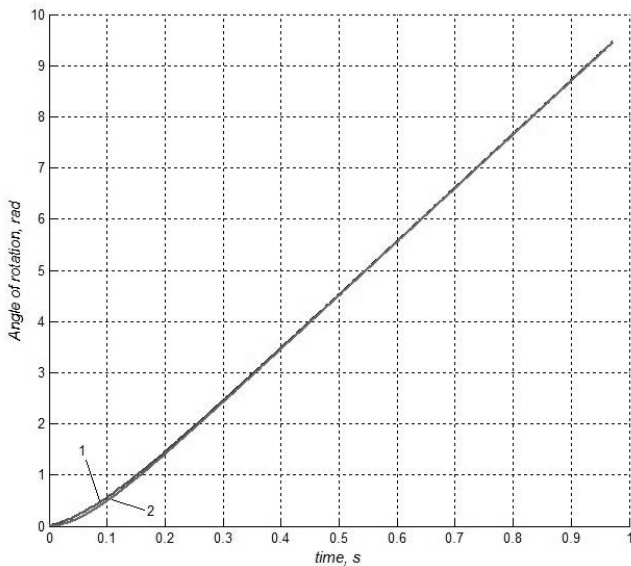

Fig.9 Data for rotation angle of motor rotor. 1 – an experimental data, 2 – a data from simulation results.

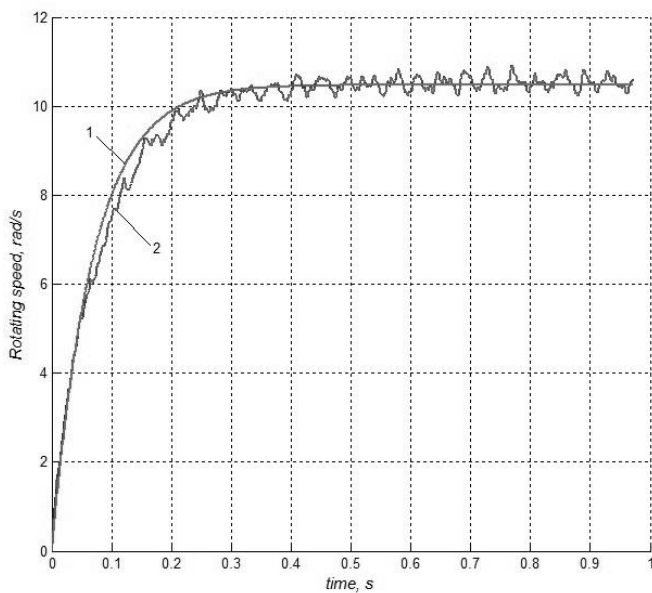

Fig.10 Data for rotation speed of motor rotor. 1 – an experimental data, 2 – a data from simulation results..

V. LCD

LCD NOKIA 5110 is placed on the platform. System parameters such as the current angle of the platform, the rotation angle of the rotor motor driving mode system can be displayed by this LCD. This is monochrome LCD with the screen resolution of 84x48 points. It is controlled by the integrated display driver PCD8544. Display settings are listed below.

- Resolution 84x48 points
- Power supply: 2,7 – 3,3 V

- Current consumption: up to 320 μ A.
- Interface: SPI
- Clock frequency: up to 4MHz

At the hardware level, work with display is carried by transmitting data or command byte via SPI. The control software module is designed to work with display. The module structure is on two levels. Functions of the lower level implement the work of SPI peripherals of microcontroller, addressing the display, setting its operation modes. Top-level functions implement displaying information. Software module allows system to display three types of information: text characters, raster images and vector graphics. Example of the display is shown in Figure 11.

To transmit each character it is required to send 14 bytes of information to the display. At a frequency of 4 MHz data exchange time spent on the transfer will be around 30 μ s. To transfer the display point requires about 6 μ s. This allows using of a software module for real-time display of textual and graphical information, for example it may be a graph of changes of the value of system parameter.

VI. MATH MODEL OF SYSTEM

From a mathematical point of view, two-wheeled platform is an inverted pendulum with a suspension point placed on the wheels. The equations describing the behavior of this object can be obtained by the Lagrange equations of the second kind [5]:

$$\frac{d}{dt} \left(\frac{\partial T}{\partial \dot{q}_i} \right) - \frac{\partial T}{\partial q_i} = Q_i \quad (5)$$

where T – kinetic energy of the system, q_i – generalized coordinates, Q_i – generalized forces. Scheme pendulum with suspension point on the wheel is shown in Figure 12. We introduce the following notation:

- φ – tilt angle of platform,
- ψ – wheel angle of rotation,
- m_p – weight of the pendulum rod,

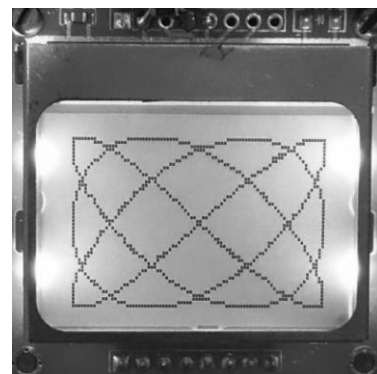

Fig.11 Example of implementation of graphics. Construction of Lissajous curves on the points in time.

m_w – wheel weight

l – distance from the rod center of mass to the point of suspension

λ – radius of gyration of the pendulum rod

r – wheel radius

ρ – radius of gyration of the wheel

(x_p, y_p) – coordinates of the pendulum center of mass

(x_w, y_w) – coordinates of the wheel center

As $y_p=0$, coordinates of the center of mass of the pendulum rod and the wheel center are related by:

$$x_p(t) = x_w(t) + l \sin \varphi(t); y_p(t) = l \cos \varphi(t);$$

Given these relations expression for the kinetic energy of the system is as follows:

$$T = m_w \dot{\psi}^2 (r^2 + \rho^2) + \frac{1}{2} m_p (r^2 \dot{\psi}^2 + (l^2 + \lambda^2) \dot{\varphi}^2 + r l \dot{\psi} \dot{\varphi} \cos \varphi)$$

As generalized coordinates we choose the tilt angle of the platform and the angle of wheel rotation.

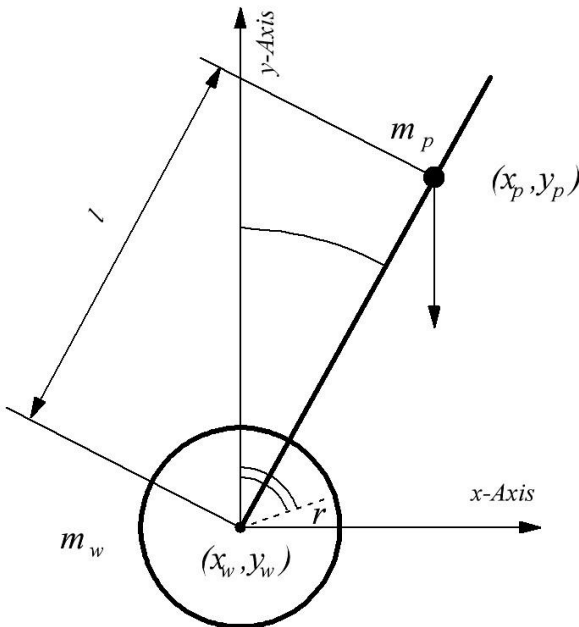

Fig.12. Scheme of the inverse pendulum suspension point on the wheel

Differentiating the expression for the kinetic energy in terms of generalized coordinates and substituting in equation (5), we obtain the equation of:

$$m_p (l^2 + \lambda^2) \ddot{\varphi} + m_p r l \dot{\psi} \cos \varphi = m_p g l \sin \varphi - 2M \quad (6)$$

$$2\dot{\psi} (m_w (r^2 + \rho^2) + \frac{1}{2} m_p r^2) + m_p r l (\dot{\varphi} \cos \varphi - \dot{\varphi}^2 \sin \varphi) = M \quad (7)$$

The expression for the motor torque is:

$$M = \frac{c\Phi}{R} U - \frac{(c\Phi)^2}{R} (\dot{\psi} - \dot{\varphi}) \quad (8)$$

Substituting (8) in equation (6) and (7) we obtain the final form of the equations of the system:

$$m_p (l^2 + \lambda^2) \ddot{\varphi} + m_p r l \cos \varphi \dot{\psi} = m_p g l \sin \varphi + 2 \frac{(c\Phi)^2}{R} (\dot{\psi} - \dot{\varphi}) + \frac{c\Phi}{R} U$$

$$m_p r l \cos \varphi \dot{\varphi} + 2 (m_w (r^2 + \rho^2) + \frac{1}{2} m_p r^2) \dot{\psi} = m_p r l \dot{\varphi}^2 \sin \varphi - \frac{(c\Phi)^2}{R} (\dot{\psi} - \dot{\varphi}) - \frac{c\Phi}{R} U$$

VII. CONTROL OF SYSTEM

By now all hardware and software modules for controlling the system components are implemented in the system. The system is in the stage of debugging of stabilization algorithms. Two control algorithms are implemented. The first algorithm assumes the linearization of the system and control using modal synthesis method. The second algorithm is based on the localization method [6]. This method was developed at the Department of Automation of NSTU and is used to control nonlinear plants. The stabilization system is based on the use of the highest derivative of the output variable of the object in the control. Control is formed by the following law:

$$u = K(F(y, \dot{y}, \dots, y^{(n-1)}, v) - y^{(n)})$$

where F – desired equation, K – large coefficient, v – setpoint. Desirable equation is given in the form of a linear differential equation. Such type of control allows suppressing nonlinearity of object.

VIII. REFERENCES

- [1] STMicroelectronics STM32VLDISCOVERY STM32 value line Discovery. <<http://goo.gl/3aSbyB>>
- [2] STMicroelectronics STM32VLDISCOVERY STM32 value line Discovery. <<http://goo.gl/KBazYE>>
- [3] Analog devices accelerometer ADXL335. <<http://goo.gl/LAslK>>
- [4] Philips Semiconductors PCD8544 48 x 84 pixels matrix LCD controller/driver. <<http://goo.gl/sO6ldH>>
- [5] Формальский А.М. Управление движением неустойчивых объектов. – М.: ФИЗМАТЛИТ, 2012. – 232 с. – ISBN 978-5-9221-1460-8
- [6] Основы теории непрерывных и дискретных систем регулирования. – 5-е изд., перераб. и доп.: учеб. пособие / А.С. Востриков, Г.А. Французова, Е.Б. Гаврилов. – Новосибирск : Изд-во НГТУ, 2008. – 476 с. ISBN 978-5-7782-1129-9

Pro-active and socially capable pedagogical agents in computer- and web-based trainings

Madlen Wuttke

Technische Universität Chemnitz, Germany

Abstract— The following paper describes in detail, in which way the development of a pro-active pedagogical agent proves to be of higher effort than compared to a conventional computer based training software. Furthermore, an experimental setup for a proposed evaluation of the developed pro-active agent is defined.

Keywords— Pedagogical Agent, Pro-Active, E-Learning, compensation, learner-centered design

I. INTRODUCTION

As previously stated [1] the current forms of interaction between humans and computers is hindered by the artificial forms of readily available channels for communication. Despite the natural form of verbally expressed information in combination with non-verbal cues, the interaction with most machines and traditional computers in particular, is still limited to a keyboard or mechanical input device. And these forms of input themselves are basically using ritualized forms of command codes instead of natural, semantic communication. So, not only is a communicational attempt with a computer limited by the designed communication input, but also by its capability of understanding.

Research has been heavily invested in designing machines to be able to interpret human language into the form of commands, while vastly ignoring the possibility to interpret non-verbal cues, like signs of fatigue or attention. The proposed pro-active pedagogical agent aims to compensate this missing but important aspect of human computer interaction.

II. PRO-ACTIVE PEDAGOGICAL AGENTS

The implementation of virtual agents as a learning companion has been widely analyzed regarding their different forms of presentation [2], their manners as well as their outwards appearance [3], [4], [5], [6] and how they should voice the learning material or their style of conversation in general [7], [8], [9]. A thorough overview of available studies concerning the different forms of a pedagogical agent's appearances and capabilities as well as their impact on a students learning success is available by Heidig and Clarebout [10].

Still, as it has been postulated by Reeves and Nass [11], the human tendency to behave socially even if the conversational opposite should happen to be a machine, has been mostly disregarded. The aforementioned research is focused on discovering key elements of depiction and

material presentation. Even the extensive meta-analysis of Heidig and Clarebout [10] did not specify aspects of input interpretational capabilities – apart from voice commands. Although the findings of Lester et al. [12] indicate a persona-effect, which again reinforces the statements of Reeves and Nass [11], this apparent need of humans to relate to the machine (or in this case the learning module itself) is widely ignored.

Yet when thinking about a traditional classroom situation, with a teacher accompanying students, other environmental information, like the focus of attention of a student, the level of noise in the classroom or environmental information, like the rooms temperature, would all be interpreted by the teacher and thereby influence the presentation of learning materials.

The developed pro-active pedagogical agent has been built with this optical capability in mind. Due to a HD Webcam, the learning system can actually watch the student as he or she progresses through the learning material. In case of distractions or a misdirected attention, the electronic educational instance is capable of intervening by pausing the material presentation, directly talking to the student and explaining the reason for the disruption and offering two ways of how to proceed: either by continuing from the point where the attention diverted away from the learning module, or by repeating the last sequence all together, to avoid missing links later on.

III. RESEARCH OUTLINE

The research was focused on the implementation of a visual and auditory feedback for the learning module about the students' reactions to the shared environment. No matter how traditional pedagogical agents are designed, behave or characterized, they still basically are merely showing information on a screen or via an auditory channel – but they keep purely passive while doing so. As long as no button on the keyboard is pushed or the mouse is actively moved to a corresponding symbol on the screen to pause the presentation, it would simply go on until a manual user input is required, e.g. to continue with the next chapter or by performing a test at the end of a lecture.

But since e-learning is heavily dependent on an individual's capability to learn on his or her own, the factor of control, while the learning material is being conveyed, is missing. That way, knowledge gaps are only identified during a learning success control. And even if the test has been prepared according to the corresponding chapters and offers to jump to the missing information to re-learn it, there is no way of knowing whether or not the

attention is kept up the second (third or fourth) time around.

By having the learning module presenting the material while constantly checking for an active and correctly focused gaze by the student, the pedagogical agent is elevated from being the passive presenter of information to an active teacher, who is capable of steering the contents as it is required.

IV. THE PRO-ACTIVE MODULE

Currently, the developed learning module is capable of identifying deviations from a user's visual perception. This was achieved by having a Microsoft HD Cam and an eye-detection algorithm which continuously tracks the user's gaze. Should this gaze be averted from the screen, for example by looking out of a window or by checking the cell phone for a text message, the electronic educational instance (EEI) is capable of pausing the presentation. This is done until the EEI re-detects the gaze to be directed onto the screen. At that time, the pedagogical agents explains why the presentation has been paused (due to a possible interruption) and offers two ways on how to proceed.

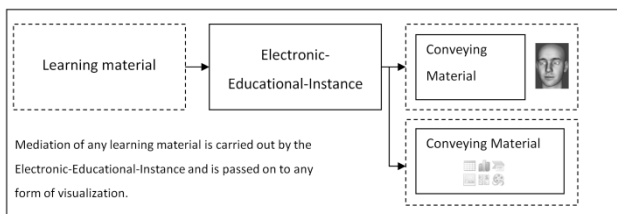

Fig. 1: The Electronic Educational Instance

The first option is to take off right where the disruption had been detected. This is suitable for any situation in which a learner was focused on the presented material but was interrupted for only a short time. As long as the student is confident about having understood the previously shown material, this has only a comparably short impact on the total learning time.

If however a student is aware that its mind has wandered off before the averted gaze or if the material was too complicated and, for example, he or she wanted to look something up in a book or on a website, the second option, to restart the current chapter, might be a more favorable option.

Supported by the EEI, the pedagogical agent is now capable of reacting to an obvious break in a user's attention. Combined with the established instructional design paradigms for preparing the learning material and the passive sensory equipment in the form of a webcam, a new form of non-verbal communication has been developed, which compensates for the usual strong need to have a directed user interaction attempt with the computer.

To check for the effect of an agent's voice and social style [13], [14], [15] two different kinds of agent vocalizations were implemented. One, in which the agent is rather friendly, socially amicable, approachable and generally eager to teach, while in the other form, the agent

is more focused, distanced and generally explaining while not using any forms of vocal slender.

V. METHODOICAL APPROACH

In addition to the pro-active pedagogical agent, the experimental setup also includes an eye-tracker (SMI RED) to adequately check for a user's focus of attention while looking at the screen. Especially, how the attention is divided between the learning material and the animated agent.

The learning material used is a narrated instruction on the Adobe Dreamweaver Suite CS3. This material has been chosen for the experiment, since it was actively used as the primary source of information for web design in the curriculum for media-communication and media-pedagogy students at Technische Universität Chemnitz, from 2007 until 2010.

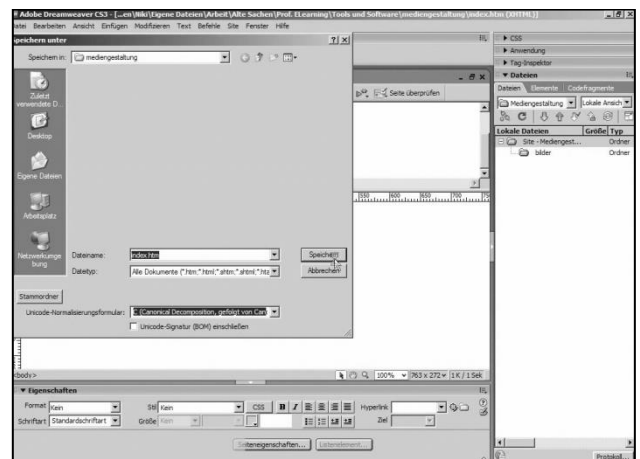

Fig. 2: The learning material as it was used from 2007-2010

The animated agent was recorded using a Kinect for Windows camera and the software FaceShift [16], which allows to render a 3 dimensional image and to animate it in accordance with the movements in front of the Kinect camera.

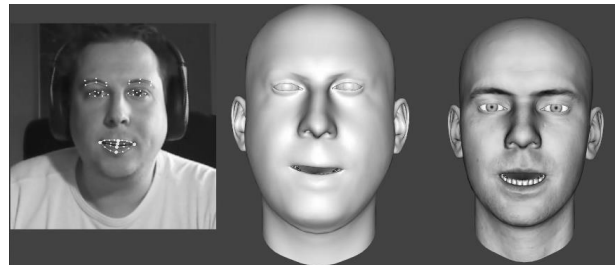

Fig. 3: FaceShift animated agent

The learning module itself is then enhanced by depicting the agent alongside the learning material (Fig. 4).



Fig. 4: Experimental setup

To be able to test for the beneficial aspects of the pro-active pedagogical agent, four experimental groups are accompanied by two control groups, resulting in a not completely crossed design, testing for three distinct features.

Group one through four do have the pedagogical agent visibly located in the lower right-hand corner of the screen. But while Group one and two have the pro-active component activated, the Groups three and four do not have this deemed to be essential feature. Furthermore, the Groups one and three have the socially amicable form of the agent, while the groups two and four have the neutral agent instead.

As mentioned before, two control groups have been implemented, which is to avert one of the main criticisms for studies conducted regarding the capabilities of pedagogical agents: that there were no tests for the learning success without the agent present.

Therefore the control groups A and B will have to learn without the depiction of the agent, although the voice is still audible (recreating the way the material has been taught from 2007-2010). Since the main focus of research is to check for the beneficial aspects of the EEI and the pro-active capabilities, the control group A will have to learn without it, while the control group B does have the EEI activated. Both control groups will have the neutral agent implemented.

Group 1	Group 2	Group 3	Group 4
Visualized Agent With Pro-Activity social	Visualized Agent With Pro-Activity neutral	Visualized Agent Without Pro-Activity social	Visualized Agent Without Pro-Activity neutral
Control-Group A	Control-Group B		
Without Visualized Agent Without Pro-Activity neutral	Without Visualized Agent With Pro-Activity neutral		

Fig. 5: Experimental groups

The experiment itself will be conducted, by guiding the participants into the room and by adjusting them in front of the screen and the eye-tracking camera. Since it has to be calibrated in order to work properly, this automated process is conducted at once and validated, as soon as the participants have been informed about the upcoming experiment and signed their consent sheet.

Next, demographic data is gathered by the usage of a web-based survey tool. Afterwards, the learning module is started and the eye-tracker starts to record the participants eye-movements. Afterwards, some short web-survey

questions about general opinions in regard to the agent and the module are gathered and the learning success control is launched.

Within this test, the participants are asked to actively apply their gathered knowledge from the learning module by recreating the navigational structures in HTML code, as previously explained by the agent. During this test, the length of mouse-movements, the necessary mouse-clicks and the time to completion are recorded. In addition, some multiple choice questions about the conveyed knowledge are presented.

At this point, the experiment is over for the two control groups. The experimental groups one through four on the other hand are confronted with a feedback form. Regardless of their factual performance during these tests, either a very good or a very bad score is presented. This is used to check if the participants now attribute their own performance to the pedagogical agent. They are consequently asked to first off rate their own performance during the test and afterwards, to rate the helpfulness of the agent during the knowledge acquisition.

Once the experiment has been conducted, the data from the self assessment, the factual performance in the practical test, the acquired knowledge during the multiple-choice test, the judgment of the agent, the logfile with all the mouse-movements and mouse-clicks, as well as the screen-capture videos and the eye-tracking data will be analyzed. Allowing to check if there is an actual benefit by applying new forms of communication channels upon a previously established learning module.

VII. CONCLUSION

Since this paper merely depicts the upcoming experimental research, the current levels of scientific research regarding pedagogical agents were described and the progress of development constituted. The experimental validation will be conducted during July 2014 and the results will be ready for publication by the beginning of the fourth quarter of 2014.

ACKNOWLEDGMENT

The research behind this paper is sponsored by the DFG Research Training Group 'Crossworlds – Connecting Virtual and Real Social Worlds'.

REFERENCES

- [1] Wuttke, M. (2013). Pro-Active Pedagogical Agents. In: Fakultät für Informatik (Ed.). Proceedings of International Summerworkshop Computer Science July 2013. pp. 59-62.
- [2] Lusk, M. M. & Atkinson, R. K. (2007). Animated Pedagogical Agents: Does Their Degree of Embodiment Impact Learning from Static or Animated Worked Examples? *Applied cognitive psychology* 21, pp. 747-764.
- [3] Wang, N., Johnson, W. L., Mayer, R. E., Risso, P., Shaw, E. & Collins, H. (2008). The politeness effect: Pedagogical agents and learning outcomes. *Int. J. Human-Computer Studies* 66, pp. 98-112.
- [4] Graesser, A. C., Person, N. K., Harter, D. & Group, T. R. (2001). Teaching tactics and dialog in AutoTutor. *International Journal of Artificial Intelligence in Education* 12, pp. 257-279.

- [5] Kim, Y., Baylor, A. L. & Shen, E. (2007). Pedagogical agents as learning companions: The impact of agent emotion and gender. *Journal of Computer Assisted Learning* 23, pp. 220–234.
- [6] Chan, T. W. & Chou, C. Y. (1997). Exploring the design of computer supports for reciprocal tutoring systems. *International Journal of Artificial Intelligence in Education* 8, pp. 1–29.
- [7] Domagk, S. (2010). Do pedagogical agents facilitate learner motivation and learning outcomes? The role of the appeal of agent's appearance and voice. *Journal of Media Psychology* 22(2), pp. 82–95.
- [8] Nass C., Isbister K. & Lee E. J. (2000). Truth is beauty, researching embodied conversational agents. Embodied conversational agents. The MIT Press, Cambridge, pp. 374–402.
- [9] Veletsianos, G. (2012). How do learners respond to pedagogical agents that deliver social-oriented non-task messages? Impact on student learning, perceptions, and experiences. *Computers in Human Behavior* 28, pp. 275-283.
- [10] Heidig, S. & Clarebout, G. (2011). Do pedagogical agents make a difference to student motivation and learning? *Educational Research Review* 6, pp. 27-54.
- [11] Reeves, B. & Nass, C. (1996). The Media Equation. How people treat computers, televisions, and new media like real people and places. New York: Cambridge University Press.
- [12] Lester, J. C., Converse, S. A., Kahler, S. E., Barlow, S. T., Stone, B. A. & Bhogal, R. S. (1997). The persona effect: affective impact of animated pedagogical agents. In: S. Pemberton (Ed.), *Human Factors in Computing Systems: CHI '97 Conference Proceedings* (pp. 359-366). New York: ACM Press.
- [13] Atkinson, R. K., Mayer, R. E. & Merrill, M. M. (2005). Fostering social agency in multimedia learning: Examining the impact of an agent's voice. *Contemporary Educational Psychology* 30, pp. 117–139.
- [14] Veletsianos, G. (2009). The impact and implications of virtual character expressiveness on learning and agent–learner interactions. *Journal of Computer Assisted Learning* 25, pp. 345–357.
- [15] Frechette, C. & Moreno, R. (2010). The Roles of Animated Pedagogical Agents' Presence and Nonverbal Communication in Multimedia Learning Environments. *Journal of Media Psychology* 22(2), pp. 61-72.
- [16] <http://www.faceshift.com/>

Methods Of Designing And Modeling Of Man-Machine Systems

Mihail G. Grif*¹, Oyunsuren Sundui*², Yevgenii B. Tsoy*³

* Novosibirsk State Technical University, Novosibirsk, Russia

¹ Professor, Head of the Department of Automatic Control Systems

² PhD student, Department of Applied Mathematics

³ Professor, Vice-Rector for International Relations

Abstract — The article deals with methods of designing and modeling of processes functioning of man-machine systems (PF MMS), based on functional-structural theory and the generalized MMS structural method of prof. A.I. Gubinsky. An algorithm for the generation of series-parallel connection operations with the additional constraints algorithm for generating alternative process, the functioning of human-machine systems on the basis of common goals operations algorithm for generating.

Index Terms – functional-structural theory, man-machine system, a set of alternatives, generalized structural method.

I. INTRODUCTION

Development of technologies for the design of the process of functioning of man-machine systems (PF MMS) in terms of efficiency, quality and reliability (EQR) is one of the dominant trends in the study and automation of projects, facilities management and decision making. System of intellectual support for decision making helps a person to analyze large amounts of information, take into account expert opinions of professional groups, formulate many possible solutions and predict their consequences, and provide justification for selection. Desire to improve the adequacy of the used models by attracting a growing number of factors considered and the expansion of alternatives creates real difficulties for the optimal operation of an embodiment of the PF MMS. Therefore, it increases the significance of approaches to optimal design of MMS, enabling rapid generation and analysis of a sufficiently large number of alternatives. Analysis of the models of PF MMS used shows that the most universal of them is functional structural theory (FST) and the generalized structural method of professor Gubinsky A.I. In [1-4], models, methods and technologies of consistent optimization of the PF MMS in terms of efficiency, quality and reliability based on the FTS were developed. However, this approach has a significant limitation as FTS is only applicable to processes without aftereffect and in the absence of dependent operations. In this paper, we propose a method to eliminate this limitation by integrating the technology of designing of PF MMS based on FTS with the method of simulating design of

those parts of the process that failed to meet the above - mentioned requirements of the FTS.

II. METHODS OF OPTIMAL DESIGNING OF PF MMS BASED ON FUNCTIONAL STRUCTURAL THEORY OF MAN-MACHINE SYSTEMS

Under the process of functioning of MMS, we consider the logical and temporal sequence of actions and operations of ergatic and non-ergatic elements of the system which are resistant to interference and lead towards reaching a goal (goals) of the functioning [1-3]. PF MMS flows in interconnected spaces of: MMS elements E , functions F , MMS states S , occurring events W and performance of MMS Q .

On the basis of the evaluation method of probabilistic efficiency, quality and reliability (EQR) of PF MMS - probability of correct (error-free) performance B , the average time T and average cost (income) V of performance, probability of timely performance $P(t < T_d)$ is a probabilistic graph, as well as rules for its reduction (enlargement).

Let us consider ways to specify an optimization model of PF MMS based on functional network, using sets of elements of MMS, functions and operations. Using the functional structural theory and the generalized structural method of Gubinsky A.I. when designing PF MMS assumes that each alternative process of functioning of MMS is defined as a functional network (FN) and seems to consist of a series of formal units - typical functional units (TFU) and their typical combinations - typical functional structures (TFS). The user describes many alternative processes of MMS as an alternative graph in Fig. 1.

Optimization problem (the generalized problem of dynamic programming) is formulated as follows:

$$\begin{aligned} K_{EQR}(A) &\rightarrow \text{extr}, \\ A &\in M_d \subseteq M_a \end{aligned} \quad (1)$$

where $K_{EQR}(A)$ is the optimality criterion for combinations of EQR criteria; M_d is the set of feasible alternatives, alternative versions of process M_a .

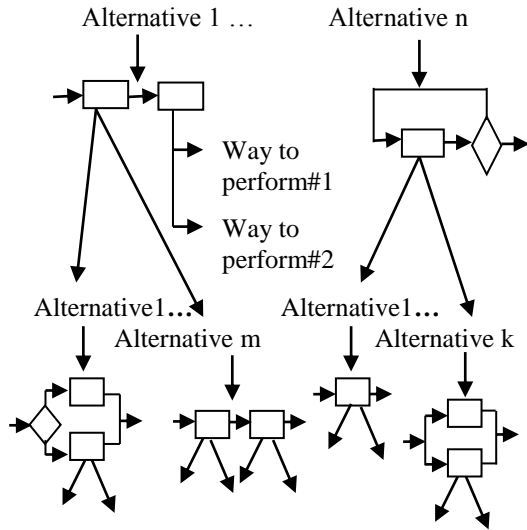

Fig. 1. Alternative graph for the process of functioning of the MMS

Probabilistic and uncertain indicators of efficiency, quality and reliability of the process (algorithm) of functioning are

$$B(A), T(A), V(A), P(t < T_d)(A), \tilde{B}(A), \tilde{T}(A) \text{ and } \tilde{V}(A).$$

Table 1 shows some of the possible formulations of optimization objectives with indicators $B(A), T(A)$ and $V(A)$. Here $P_{ogr}(A)$ - restrictions on how to perform compatibility components of alternatives in the form of a predicate - «If $P_{ogr}(A)$ is a "truth" A satisfies the constraints of the problem ».

TABLE 1. SCALAR AND VECTOR OPTIMIZATION PROBLEM WITH PERFORMANCE $B(A), T(A), V(A)$

Criterion	Constrains	Notes
$K(A) \rightarrow \max$ $A \in M_d$	$V(A) \leq V_d$ $T(A) \leq T_d$ $P_{ogr}(A)$	$V_d \geq 0$ $T_d \geq 0$
$T(A) \rightarrow \min$ $A \in M_d$	$V(A) \leq V_d$ $B(A) \leq B_d$ $P_{ogr}(A)$	$V_d \geq 0$ $B_d \in [0,1]$
$V(A) \rightarrow \min$ $A \in M_d$	$T(A) \leq T_d$ $B(A) \leq B_d$ $P_{ogr}(A)$	$T_d \geq 0$ $B_d \in [0,1]$
$F_1 = c_1 B(A) - c_2 T(A) - c_3 V(A) \rightarrow \max$	$P_{ogr}(A)$	$c_{1i} \geq 0, i = 1..3$

The operation $O \equiv O(F, E, Q)$ is the process of performing function F by element E in the state of MMS S where Q is indicators of efficiency, quality and reliability.

Separate process of functioning of the MMS (functional network) is represented as a superposition of TFS:

$$O_{z=TFS_i}(O_{i_1}, O_{i_2}, \dots, O_{i_k}) \quad (2)$$

where $TFS_i \in M_{TFS}$, O_{i_j} - simple or composite operation.

Two operations with a matching function $F - O(F, E_1, Q_1)$ and $O(F, E_2, Q_2)$ are alternative ("parametric") ways of performing the operation, as well as componential operations $O_{TFS_i}(O_{i_1}, O_{i_2}, \dots)$ and $O_{TFS_s}(O_{s_1}, O_{s_2}, \dots)$, $i \neq s$ are "structural".

In [4], a method is developed for sequential optimization of PF MMS of model FN in the overall scheme of sequential analysis of options with step-by-step construction of partial solutions. The specific algorithm of step-by-step construction is determined by selection rules of partial solutions (subnets) \mathcal{g} , subject to the development of each step, and a set of tests ξ that screen those which cannot be completed to the optimal. Variation of parameters \mathcal{g} and ξ leads to different algorithms of sequential analysis of options for the optimization of PF MMS on functional networks.

Most fully reviewed models above and methods of optimal designing of PF MMS were originally implemented as a hybrid expert system (HES) INTELLECT-2 which operates on an IBM PC in an Operating Environment Win32, with programming languages C++ Builder and Visual Prolog.

Currently, a new version of the HES design of MMS and decision making INTELLECT-3, which, unlike INTELLECT-2, has fundamentally important new capabilities for the user: it inserts alternative TFS in the functional network section, bounded by two arcs; builds all isomorphic representations of an alternative graph; generates specific algorithm of directed enumeration in manual and automatic mode; and conducts an effective algorithm parallelization of directed enumeration for multiprocessor and multicore computers.

III. INTEGRATION OF OPTIMIZATION MODELS OF PF MMS WITH SIMULATION MODELING METHOD

In [5], an integration scheme of the method of optimal designing of PF MMS based on the FTS was presented with a method of simulation design of efficiency, quality and reliability indicators of individual parts of the process, which cannot be described by the functional network.

The essence of the approach is as follows:

1) Many alternatives of PF MMS are described by one of the most popular and visual notations of describing business processes - EPC. This notation is supplemented by a special unit for specifications of alternative sites of PF MMS in Fig. 2.

2) Each block similar typical functional units (TFU) in the functional network (FN) is set to execute probabilities of outcomes (correct, error) as a function of various factors, such as the illumination of the workplace, employee qualifications, etc. Furthermore, the formula for calculating (changing) factor values during the execution of this block.

3) The analysis of a set of alternatives of PF MMS for the provision of sites in it that cannot be described by a model of FN. For example, if a factor is found in the linear portion of the process that influences the outcomes of the first and the last operation, the entire site cannot be described the FN. Or, for cyclic portion of the process it turns out that the factor at the input of the loop can be changed inside the loop.

4) For the identified areas of the process that cannot be represented by FN, simulation modeling of equivalent block indicators - $B(A)$, $T(A)$ and $V(A)$ is conducted, which replaces this section. It should be noted that this block is usually an alternative in Fig. 2.

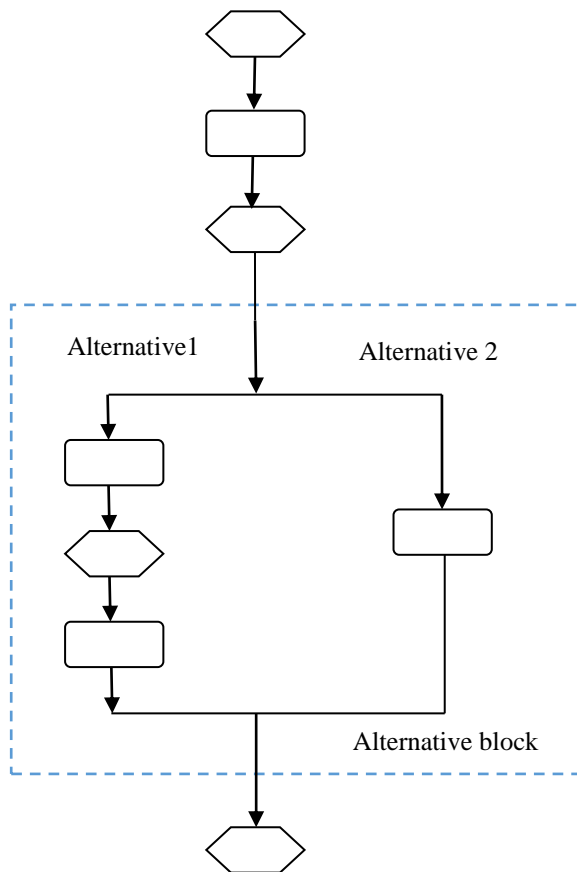

Fig. 2. Example of section to describe the process with an alternative block

5) Once there is no more unrepresented FN area in a variety of alternatives of PF MMS, described in EPC notation system, FN EPC notations are relayed to the FN.

6) Solutions for optimal designing of PF MMS of model FN are carried out in HES INTELLECT-3.

Program complex of simulation modeling of PF MMS is designed for the operating system Windows, written in programming language C#, using a library of Microsoft .NET Framework 2.0 and charting component Microsoft Visio. Compilation is done in an environment of object-oriented programming Microsoft Visual Studio 2010. It is applied with HES INTELLECT-3.

The developed software was used when designing the optimal structure of the Information Technology Service of the National University of Mongolia [6] (IT Service, NUM) in Fig. 3.

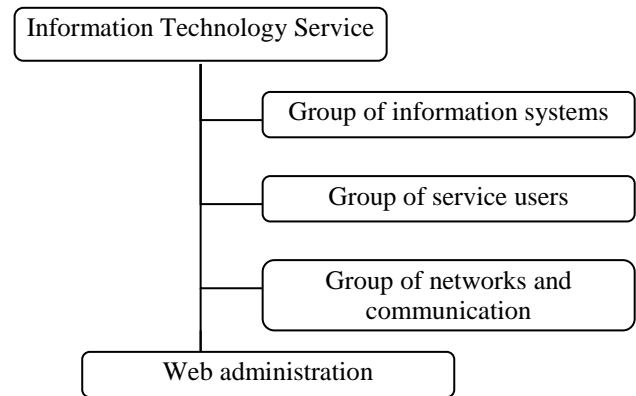

Fig. 3. Overall structure of the IT Service, NUM.

Business processes of functioning of the IT Service, NUM were built, and the problem of optimizing the process of eliminating network failure of the NUM by the criteria for the probability of correct execution, the average time and cost of elimination failure was solved, which significantly improved the efficiency of the service.

IV. CONCLUSION

The new technology of optimal design of PF MMS is introduced, which removes some restrictions of functional structural theory of MMS by applying the method of simulation modeling.

REFERENCES

- [1] Adamenko A.N. Information Controlled Man-Machine Systems: Research, development, and test: Directory / A.N. Adamenko, A.T. Asherov, I.L. Berdnikov., etc.; edited by A.I. Gubinsky and V.G. Evgrafov. - Moscow: Mechanical Engineering, 1993. - 528 pages.
- [2] Gubinsky A.I. Reliability and quality of functioning ergatic systems. - Leningrad: Nauka, 1982. - 270 pages.
- [3] Gubinsky A.I. Ergonomic design of ship control systems /Gubinsky A.I., V.G. Evgrafov - Leningrad.: Shipbuilding, 1977. - 224 pages.
- [4] Grif M.G. Automation of designing of PF MMS on the basis of serial optimization / Grif M.G., Tsoy Ye.B. - Novosibirsk: Publishing House of the NSTU, 2005. - 264 pages.
- [5] Grif M.G. Design and optimization of business processes on the basis of functional networks device / Grif M.G., Nikityuk A.A. // Computer Science: Problems, methodology, technology: materials of the 11th International. Scientific Conference, Voronej, February 10-11, 2011 in 3 volumes - Voronej: VSU ITC 2011. - Volume 1, pages 209-212.
- [6] www.num.edu.mn

Case Study of Structure Oriented Evaluation Model

Uranchimeg Tudevdagva^{1,2}

¹Mongolian University of Science and Technology, Baga Toiruu 8, Ulaanbaatar, 210646, Mongolia

²Technische Universitaet Chemnitz, Str. der Nationen 62, S-09111, Germany

Uranchimeg.tudevdagva@informatik.tu-chemnitz.de

Jargalmaa Dolgor³

³Ikh Zasag International University, B.Dorjiin Str. Khoroo 4, Ulaanbaatar, Mongolia

d.jargalmaa@yahoo.com

Bayar-Erdene Lhagvasuren¹

¹Mongolian University of Science and Technology, Baga Toiruu 8, Ulaanbaatar, 210646, Mongolia

l_bayarerdene@yahoo.com

Abstract— This paper described evaluation process of distance learning course. The distance learning course was developed by Technische Universitaet Chemnitz. Target group of this e-course was foreign students. Students from Asian countries attended to this course since 2010. Advantage of this course is opens opportunity to attend to German University lecture from home country and collect experience and understanding in German education system. The TUC did summative evaluation of this distance course to get feedback and recognize advantages and weaknesses of offering course. The evaluation team used for evaluation process structure oriented evaluation model, which is developed specially for evaluation of e-learning processes.

Keywords— distance learning; evaluation; SURE model; evaluation model; goal structure.

I. INTRODUCTION

The education is one of the key sectors of each country not depending on their development and rank in the world. The rapid progress of information and communication technologies, internet and computer techniques are prepares for education system friendly environment to cooperate universities of different countries. Many universities are actively works on the development of e-learning courses. Last exploration in the e-learning was so called Massive Open Online Course (MOOC). Unlimited participation and blended version of classical teaching materials like readings, video lecturers and e-learning materials like online and offline forum, web based collaborative environment, all these arguments gives to learners opportunity to increase knowledge and attend to lessons of top universities of world. The MOOC has a lot of advantages but has some weaknesses, too. Too many participants in one course are sometime not fitting to expectation of single inexperienced participants. In this case they can start with small group and can collect first step experience in distance learning. Such us single activity is helpful to oriented in big virtual classroom.

For small group and learners offers different e-learning distance course in frame of universities cooperation. The example is distance learning course between universities of Germany, Thailand and Mongolia. The Technische Universitaet Chemnitz established e-courses which oriented to foreign students [1]. Main challenge of this idea is to support

foreign students and faculty with user friendly collaborative e-learning environments and open them opportunity to attend German university lectures from distance.

To develop quality of the offering course and to get feedback on the satisfaction of learners TUC did summative evaluation by SURE model on course "Practice-Oriented Introduction to Computer Graphics". The TUC created Video lectures for distance learning in 2010 and started offer it open for international learners. This course is part of the exchange program "ICCS - International Courses of Computer Science" [5].

Students who plan to study in Germany can start with distance learning, for instance with offered course: "Practice-Oriented Introduction to Computer Graphics". Content of this distance course designed for online and offline types. OPAL course content covers next main subjects. There are:

- Introduction to basic terms and concepts
- Basic hardware architectures
- Basic concepts of graphical standards and libraries
- OpenGL rendering pipeline
- In-depth OpenGL programming
- Illumination techniques
- Real time shadow computation
- Animation techniques

Requirements for learners are: basic programming skills and experiences in language C/C++.

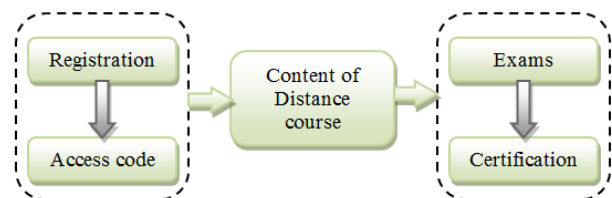

Fig. 1. Distance learning process diagram.

The distance learning process consists three main parts (see Fig.1). First student have to register by online to course. After successful registration student will receive confirmation about

enrollment and unique access code to video lecturers. Using that code student can login to e-learning support platform of TUC which called OPAL (Online Platform fur akademisches Lehren und Lernen). This is learning management system which serves universities of Saxony, Germany. But student can access only to materials of "Practice-Oriented Introduction to Computer Graphics" distance course.

Duration of study is same with TUC schedule of academic year. It means student from distance will have access to learning materials during three months. Speed of study and time management in whole could be organized by student. A student can login to OPAL course by own time and can communicate with Professors by e-course forum or by emails. In end of academic year student has to finish giving project for exam. Each student has to submit complete solution of project to OPAL course. Then is automatically sends to corresponding professor via examination board. If professor evaluated project successful student will receive certificate with confirmation on 3 credits of study. Faculty of Computer Science did summative evaluation of "Practice-Oriented Introduction to Computer Graphics" distance course by structure oriented evaluation model.

II. EASE OF USE THE EVALUATION PROCESS

A. Short introduction to SURE model

The structure oriented evaluation (SURE) model developed for evaluation of e-learning based on the general measure theory [3]. The SURE model includes eight main steps. These are: Definition of key goals, Definition of sub goals, Confirmation of evaluation goals, Creation of checklist, Acceptance of checklist, Data collection, Data processing and The evaluation report.

Each steps plays equal important role in evaluation process.

In first step of SURE model, evaluation team has to define the key goals of evaluation. The achievement of these key goals is essential for the achievement of overall objective of e-learning. If one of the key goals is failed, then the e-learning process will be evaluated as failed.

Second step focused to define sub goals. Here the key goals that were defined in the first step can be described in a more detailed version. For that sub goals can be used. Sub goals can be interpreted as different ways to reach a key goal. Hence the SURE model supports series and parallel goal structures.

In third step the evaluation team has to confirm the final version of evaluation goals which has been defined during the previous two steps. When all members of the evaluation team are have been accepted the logical structure of evaluation goals, which should be fixed by a protocol. This is helpful in avoiding future conflicts between evaluation team and involved groups of e-learning.

Step four defined method of data collection. The checklist is the most used type of data collection. This is a well-developed data collection method and there are many commercial and open source software solutions to create online surveys or checklists. The checklist of SURE model has to be created based on confirmed goal structure. To create a

checklist, one can use different online software. The weakness of existing software solutions is that they cannot take reference to logical structure of the evaluation goal. Moreover they don't include score calculation modules as they are required by the SURE model. Formulation of questions is only one part of checklist. When questions are ready evaluation team has to decide which type of a survey to be used for checklist. Depending on the target group of evaluation, design of the checklist can vary. The evaluation team has to focus its attention on this aspect carefully.

Fifth step directed to confirmation of result of previous step. The evaluation team has to confirm formally the checklist. The team also has to check whether the checklist is adapted according to the logical structure of evaluation goal, whether the questions are easy to read, understandable and no-dual meaning, whether the questions are clearly formulated, whether there are any grammatical and semantic errors in sentences. Only the accepted checklist can be used for data collection.

Step six defined technique of data collection. Data can be collected on different ways. If it is paper based version, it can increase the subjective influence, because these data have to be tabulated by using human resources. If it is a web based online version, it can be more objective. There are several techniques for data collection: surveys and questionnaire, tests and assessments, interviews, focus groups, action plans, case studies, and performance records [2]. However, the SURE model should use the online survey.

Seventh step is new contribution of SURE model. One advantage of SURE model is this model can process collected data by specially defined calculation formulas which are adapted to the logical goal structure of evaluation. In detail we refer to [4].

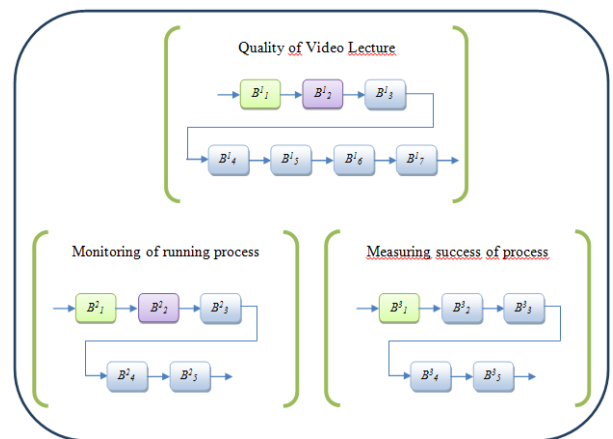

Fig. 2. Space for logical structure of evaluation goals.

In step eight the SURE model can produce quantitative and qualitative results. First five steps outcomes insure qualitative part of the evaluation. Step 6 and 7 insure quantitative part of evaluation. The evaluation report has to include both parts of the evaluation process. The evaluation report makes visible outcomes and findings of the evaluation process. The type of reports can be different depending on the audience to whom the report is addressed. By SURE model we can calculate several evaluation scores. Which evaluation score can be used for

what, can be decided by the evaluation team. The graphics and charts can be generated by SURE model application automatically, and these graphical representations can be used for the report. Evaluation report has to be delivered to stakeholders or audiences at appropriate times. Else all effort of evaluation team will be failed. As a rule all interested groups expect a quick report after data collection. Usually after collection of data until generating the final evaluation report there is a delay in fixing results and facts.

No	Question	Impact	Comment
1	Information about goals of course was clear	Totally agree	
2	Information about advantages of course was clear	Agree	
3	Information about course duration was clear	Agree	
4	Information about course schedule was clear	Agree	
5	Information about course exams was clear	Agree	

Fig. 3. Data collection by online survey.

B. Logical structure space for evaluation

The evaluation team followed above explained steps of SURE model and started with definition of key and sub goals. After first three steps evaluation team defined and confirmed logical structure of evaluation goals (see Fig.2). During first two steps process was recognized different expectations of stakeholders from evaluation process. To fit all expectations of stakeholder evaluation team defined 3 different logical goal structures. In first logical structure we have seven key goals. It means this structure will be evaluated successful only if all defined key goals are achieved own targets. Just one of these key goals is failed then general result of evaluation process will be unsuccessful. This rule is valid for other two structures, too.

According to the confirmed logical structure checklist was created and data was collected by online survey. The online survey for data collection was designed in beta tool of SURE model (see Fig.3).

Each question has a drop down selection list. This list includes following choices: Totally agree = 5; Agree = 4; Neutral = 3; Disagree = 2; Totally disagree = 1; Not applicable = 0.

Each question has a comment field additionally. If the user selects 'Not applicable' as answer, the comment field is activated and the user can enter there a comment. Moreover, if user selects as answer 'Not applicable' we completed this answer by average over remaining answers. Each learner received unique access code to the online survey by email. That guarantees the anonymity of the survey. Forty six learners attended to this distance learning since 2010, nine participants responded to the survey.

III. OUTCOME AND RESULT OF EVALUATION

The estimation values for the evaluation score: 0.79 for Quality of Video lecture; 0.74 for Monitoring of running learning process and 0.75 for Success of running process.

This evaluation had several advantages compared with the previous evaluations:

- Three different logical structures have been considered which were adapted to the different expectations of stakeholders on evaluation.
- The data collection was performed as online survey by means of the SURE model tool based on a common checklist.

All evaluation scores are higher than 0.5. This indicates an over average satisfaction for all three groups where Quality of Video Lecture was evaluated highest with an empirical evaluation score of 0.79. This reflects an average satisfaction of users at a rate of 79%. Based on the evaluation results, it can be summarized that the distance learning course "Practice-Oriented Introduction to Computer Graphics" runs successfully. However, we have to note that sample sizes are quite small such that these results are to consider as orientation.

CONCLUSIONS

We described in this paper use case of distance learning between European and Asian countries and evaluation of the offered distance e-course. Next summaries we can do here. First, evaluation results confirmed this distance course run successful and have to be kept for further development. Some administration parts and information components should be improved in next distance course. Second, used structure oriented evaluation model was more objective than usual linear model. The evaluation team has to be careful define key and sub goals of evaluation. In the evaluation team should include members of each involved group of evaluating course. The checklists for data collection have to design well and cannot include dual meaning questions.

English courses which offering from German universities gives opportunity to integrate foreign students to German Universities step by step. The feedback of participants such us distance course confirmed interest of foreign students in such type distance learning. To prepare English course and offer it open will be useful to German Universities to attract self-motivated good students in real classroom. Universities of developing countries and German universities can develop similar distance courses in cooperation, further.

REFERENCES

- [1] Learning module: Tele Lecture "Practice-Oriented Introduction to Computer Graphics", (2014) [Online] Available: <http://www.tu-chemnitz.de/informatik/iccs1/index-modul1.php.en>.
- [2] Phillips, P. P. et al. (2010). ASTD Handbook of Measuring and evaluating training: Printed in USA ASDT Press. 2010.
- [3] Tudevdagva, U. & Hardt, W. (2011). "A new evaluation model for eLearning programs", Dezember 2011, Chemnitz, CSR-11-03. ISSN 0947-5125.
- [4] Tudevdagva, U. & Hardt, W. (2012). "A measure theoretical evaluation model for e-learning programs". In Proceedings of the IADIS on e-Society 2012, March 10-13, 2012, Berlin, Germany, pp. 44-52. 978-972-8939-88-5.
- [5] Web site of International Informatik- and Convention Center Sachsony, (2010), [Online] Available: <http://www.ibs-laubusch.de/1/mission/>.

Object Oriented Medical Technical Expert System

Yumchmaa Ayush¹

¹*Power Engineering School, Mongolian University
of Science and Technology, Ulaanbaatar,
Mongolia*

yumchmaa@must.edu.mn

Davaasuren Ravdan²

²*Department of Biomedical engineering, National
Center for Maternal and Child Health,
Ulaanbaatar, Mongolia*

ravdandavaasuren@gmail.com

Abstract - This paper describes object oriented medical technical expert system. The rapid development of Information and Communication Technologies (ICT) opens many opportunities to use artificial intelligence in public services such as education, social insurance, customs, taxation, in particular in health. The development and use of medical expert system in medical is essential. In this paper we define key concepts of medical technical expert system. Main contribution of this application is to do research on the solution of specific expert system design with targeted group like young doctors and medical techniques engineers in hospitals.

Keywords - *object oriented technique; experts system; application of expert system; specific expert system; medical technique engineer*

I. NEEDS AND REQUIREMENTS

In recent years, commonly high-performance equipment for diagnosis and treatment in our country are supplied. Reform of the government in the framework of implementing the health-Mongolian rural hospitals are paid special attention to the new equipment. Modern high capacity equipment installed in Centralized diagnostic and treatment centers in 11 provinces. It is first used. The principal objective of our undergraduate program is to prepare students for productive careers in the field of biomedical engineering. Biomedical engineers in Mongolian University of Science and Technology starting from 1996-1997 academic years. Because of the economic transition period in Mongolia, hospitals have been receiving a lot of medical equipment from developed countries. Since 1997 over 140 students learned Bachelor degrees and 25 students learned Master degrees successfully in Engineering in Medical Equipment/Biomedical engineering. Now there is a growing need for qualified professional personal to work with new equipment. Therefore, It is essential to have inherited, highly qualified with many years of experience as the technical specialist knowledge of engineer. The vocation for many years was an amazing experience, experienced engineers can be called

an expert. Maybe this perception is different for each sector. Specific form is known as a highly educated, professional experience, that practical knowledge of the features found in different circumstances have been for a long time. Therefore, we need to disseminate valuable knowledge of many years experienced engineers in other young biomedical engineers.

II. EXPERT SYSTEM

An expert system is the software which helps to solve different problems in various fields. There are key definitions about expert system: "...Expert system is an intelligent computer program that uses knowledge and inference procedures to solve problems that are difficult enough to require significant human expertise for their solution. An expert system is a computer system that emulates the decision making of a human expert..." [4], "...Expert systems are computer applications which embody some non-algorithmic expertise for solving certain types of problems..." [6].

The expert system is the one of the basic research directions of the artificial intelligence. Exploration of the software with the database was good and basic background for the development of expert systems. With this exploration capacity of database increased dramatically. In order to develop and use of health information database, to analyses complex problems, and to develop and use intelligent algorithms or solutions in decision making processes.

An expert system versus software with the database is included into architecture not only database, also include knowledge base of experts and database for decision making rules.

Usage of the expert system depends on the implementation field and can be different in application. Various types of expert systems are used for decision-making support to define medical diagnosis and treatments. These two main applications are started implement in medicine early with development of artificial algorithms and high technology.

Health organizations in rural areas are understaffed or lack of professionals. Young professionals in most cases prefer to work in urban areas. This circumstance requires the use of ICT in the development of human resource, information and knowledge sharing, and introduction of new technology and best practices. Therefore, we are focusing to the doctors, engineers and nurses. The proposed expert system will support them to optimize decision making by them without consulting with experts. The decision support expert system supports young doctors and medical engineers to adapt the new environment and to keep motivation to work in rural areas. There are two user groups: doctors and engineers.

Expert system properties

The expert system is different to the other program, including the following properties.

- Something of science knowledge is not simulated, but simulating the activities of the human brain. It is main characteristics the expert systems to distinguish of mathematical formulation and computer animation modeling. However to reflect the main method of the expert's decision making process.
- Program is further of simple operating logic in addition to reasonably estimate, which is based on a knowledge of trends. Knowledge is located the specific form or form of argumentation in a separate database, it called a knowledge database.
- The basic issues are more used than fixed algorithms that near or evristik approach. Evristik is based on impact rule (rule of thumb) and called science by way of.
- The advantage of this method is not required strictly defined information and the results is highly of probablity to true.

Expert systems are different of artificial intellectual sector apart from other programs.

- Expert systems interact with the objects in the real world. In such cases, personal experience and feelings are more necessary. The most artificial intelligent programs have research directions and is very focused the mathematical formulation. However the consult program is attributed science research to introducing life.
- Very productive characteristics of this program are attributed to another artificial intelligent program. In other words, the result's time is short. Because the expert system have to make as an expert in the short term.

The most important feature is the ability to explain why such a solution with an. In other words, the program have assurances to the result is true. [12]

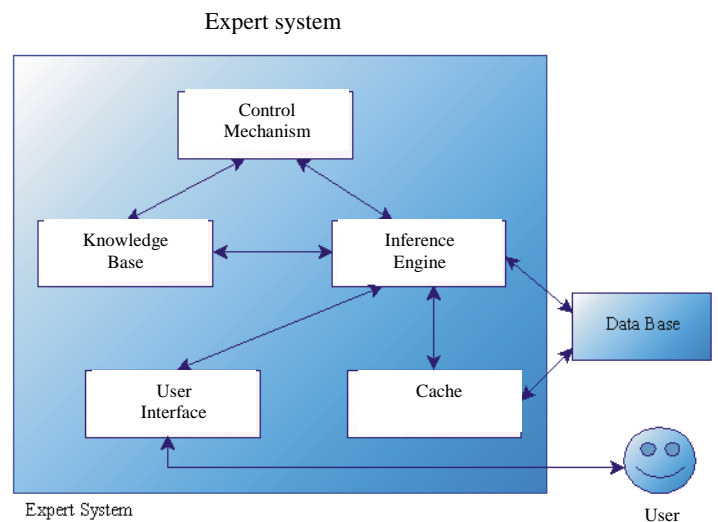

Picture1. Basic elements of expert system

Advantages of medical expert systems are:

- Centralized database of the chronically diseases;
- Knowledge database of high level expert's;
- Centralized data bank of patients treatment stories;
- Self-improvement opportunity of decision making rules;
- Simplified and improved decision making processes;
- Time management;
- Accuracy of information and data;
- Knowledge and best practices sharing;
- Support for young doctors and engineers in continuing professional education and research and development.

III. OBJECT ORIENTED MEDICAL TECHNICAL EXPERT SYSTEM

It is called an advisory software program including knowledge base and database. This is called expert system, depending on the program in computer science, artificial intellectual. This program gives the result of effect human decision making process. That is the main distinctive feature of other similar program. In other words, the most programs have the traditional forms of unchanged database, but this is different that consulting database is enriched self knowledge by the program. It is a special type of database. That is the same database, but the main difference is in the form of a database on a regular basis. But the fact that funds can be increased to improve the knowledge of the human brain is similar to the accumulation of knowledge. Human can explain after any decision necessary, why such a decision reached?

Expert systems are all expressed in the form of software features.

Medical equipment has become an important component of modern health services. Current trend indicates that major

medical equipment is increasingly being deployed in the districts to increase the diagnostic and treatment capabilities of primary health care. However, treatment and diagnosis of many types depending on the function type. And there are the many types of complex equipment operation and equipment of the same type, it is impossible to know every one of them is different technical solutions. Therefore expert systems will be very important for the hardware multiple roles, their basic maintenance of complete and cause of damage from the failure of alternative knowledge of the named equipment in database. Because hospitals have too many medical equipment for one engineer, that is problems of repair after the warranty period service took advice complications. Therefore expert systems are necessary to introduce in medical engineering.

Object-oriented or object-orientation is a software engineering concept, in which concepts are represented as "object". Medical devices, depending on what type of object the concept of specialized may consider repayment equipment. For example: Computed Tomography. On a regular basis, the medical imaging community announces faster and more accurate features, methods to improve image quality or lower patient exposure, new applications for imaging equipment and new technologies and modalities. Object-oriented medical expert system is a complete database of an expert system for independent medical equipment of diagnostic and treatment. So that, engineer improved advanced knowledge, that is able to serve, even in countryside areas saving time and more opportunities to operate equipment advantage. Involved with, there were many changes in the technical solutions. So there is similar to basis for any of the items that should have good knowledge of the basic concepts necessary. Therefore, experienced engineers valuable knowledge to simulate at the level of experts and for young experts recommend for an application form is to meet the public needs.

Medical equipment for normal operation is a precious human life, as well as the reliability of the country's population growth and social development will be a valuable contribution.

IV. CONCLUSIONS

Consultant to processing a program is known to be a complex problem. To processing the consult program is due to the time required to introduce the issue was raised for biomedical engineer. Medical equipment for diagnose and medical procedure is developing very fast. We need good expert knowledge for this field. Object oriented medical technical expert system should be good basic for collect and use top experiences and knowledge which

[9] , 2010, pp.20-26.

collected by engineers and experts in this field. Human life is depending not only from Doctor, it is depending from medical technique which using for diagnose and in medicine. To serve and install medical equipment is highlighted important engineering function in medicine. Using Object oriented medical technical expert system we can distribute knowledge and experiences for top engineers to outside of capital city and for new engineers and Doctors.

Expert system can be used not only for this target, it could be used for different advanced training courses for engineers and for university where producing medical engineers. Object oriented medical technical expert systems can be useful to increase quality of service in medicines.

REFERENCES

- [1] A. Barr, and E. A. Feigenbaum, "*The Handbook of Artificial Intelligence*", Vol.1. William Kaufmann, Inc., 1981.
- [2] F. R. Echeverría and C. R. Echeverría, "*Application of expert systems in medicine*", Proceedings of the 2006 conference on Artificial Intelligence Research and Development, IOS Press Amsterdam, The Netherlands, The Netherlands 2006, pp.3-4.
- [3] J. C. Giarratano and G. Riley, "*Expert systems: principles and programming*", PWS-KENT Pub. Co., 1989, 632 pages.
- [4] M. Mcleish and M. Cecile, "*Enhancing medical expert systems with knowledge obtained from statistical data*", Annals of Mathematics and Artificial Intelligence, Vol.2, 1990, pp.261-276.
- [5] T. Uranchimeg and N. Munh-Ochir, "*Usage of the object oriented method in the decision making process for expert system*", Proceeding of PES, MUST, Ulaanbaatar, 2009, pp.15-17.
- [6] H. Pandza and I. Masić, "*Expert systems in medicine*", Pub-Med, 1999, 53 (3 Suppl 3), pp.25-7.
- [7] A. Yumchmaa, and T. Uranchimeg, "*Decision support expert system for medical engineers, problems and solutions*", Proceeding of Health and Young Researchers scientific conference, Ulaanbaatar, Mongolia, 2009, pp.19-24.
- [8] N. M. A. Zahrani, S. Soomro and A. G. Memon, "*Breast Cancer Diagnosis and Treatment of Prophetic Medicine Using Expert System*", Journal of Information & Communication Technology, Vol. 4, No. 2

Design of adaptive systems for control of objects with changing parameters and delay

Yadryshnikov Oleg

The department of Automation in NSTU
Novosibirsk State Technical University
Novosibirsk, Russia
Email: oleg_yadr@mail.ru

Abstract— this paper resolves the task of synthesis of the adaptive regulator for object with delay which has significantly changes the parameters during work. The objective is solved by means of numerical optimization, the robustness is provided with optimization for two objects with extreme values of parameters. Also the variant a set decomposition of values of parameters of object on subsets with the subsequent synthesis the robust regulators is offered for each of the received subsets. The block diagram of received adaptive system is offered. The method is explained on object from real practice. Numerical optimization is performed by modeling in the program VisSim.

Keywords — *adaptive systems; changing parameters; delay; adaptive regulator; numerical optimization*

I. INTRODUCTION

The robust control of non-stationary objects extremely actually [1]. The robust regulator has to provide steady control with acceptable quality provided that model parameters of object change or are known insufficiently precisely [2-5]. Success of control is reached not due to changes of the regulator model but due to search such its universal model which would provide the solution of an objective at any possible combinations of model parameters of object. The solution of an objective can be unattainable such method. Adaptive regulators can change parameters of the mathematical model depending on the current model parameters of object unlike the robust regulators. Class of tasks, which can be solved by such way, is significantly more widely and results can be considerably better. The main difficulty of realization of adaptive systems consists, first, in definition of the current object model, and secondly, in calculation for this current model of the best (or accepted) regulator [6-7].

Simplification of a method of solution of this task can be reached by splitting options of possible mathematical object models into a calculating set and use to methods of robust control within this set. In this case the private subtask of robust control becomes simpler in comparison with attempt of ensuring demanded properties of system by means of the only robust regulator. Detailed identification of all parameters of object in this case isn't necessary as enough to provide only recognition of characteristic signs of object model for reference of the current model to one of previously allocated classes.

II. THE PROBLEM STATEMENT

Let the object of control have the following mathematical model:

$$W_O(s) = \frac{k}{(T_1s+1)(T_2s+1)\dots} \exp\{-s\tau\} \quad (1)$$

Non-stationary properties of object consist that in all incoming in this function parameters of its model can change in some advance known limits, namely: k - gain coefficient, T_i - a constant of time, n - an order of model and τ - a constant of time of a delay element. The output signal of object $Y(t)$ has to be as more as possible precisely to coincide with a reference signal $V(t)$, the object is influenced by an unknown interference at the same time parameters of object model slowly and unknown character change in time. Influence of unknown interference describes as a rule the ratio:

$$Y(t) = X(t) + H(t) \quad (2)$$

Here $H(t)$ – unknown interference, $X(t)$ – operated a component of the output signal, described by a ratio in operator area:

$$X(s) = U(s)W(s) \quad (3)$$

Development of the device, which forms a signal of control $U(t)$ on the basis of a reference signal $V(t)$ and an output signal of $Y(t)$, is a problem of synthesis of the regulator. As a rule, the regulator is realized in the form of the linear transfer function $W_R(t)$ on input which is fed the difference between the ordered signal and the output signal, called by an error of control $E(t)$:

$$E(t) = V(t) - Y(t) \quad (4)$$

If parameters of transfer function (1) change in time, the robust regulator remains invariable whereas the adaptive regulator has to change depending on these changes:

$$W_R(s) = W_R(s, n, k, T, \tau) \quad (5)$$

Piecewise robust regulator in our concept is the regulator which mathematical model depends on one parameter that's number of a subset to which current state of object model is referred. The most widespread structure of the regulator has an appearance of a consecutive PID controller:

$$W_R(s) = k_p + k_I / s + k_d s \quad (6)$$

Here k_p , k_I , k_d - coefficients. In case of the piecewise robust regulator these coefficients can be fixed of beforehand specified subset.

III. EXAMPLE OF SPLITTING OF OBJECT PARAMETERS ON SUBSETS

One of the simplest options of splitting a set of object parameters on subsets consists in splitting area of admissible values of each of changing parameters. For example if in (1) n - an integer in the range from 3 to 5, it gives automatically splitting into three subsets in this parameter. Continuously changing parameters T , k and τ can be split into any quantity of intervals. We can apply splitting intervals into two if there are no powerful bases for other choice. If as a result of the task solution we receive that such splitting insufficiently we can apply smaller splitting of intervals on one or several of the chosen parameters.

More intellectual approach consists in search of regularities of joint influence of parameters on quality of system and respectively on a regulator choice. The analytical analysis of influence of these parameters or combination of received regulators by results of their numerical optimization can be for this purpose used. It is very difficult to develop an analytical method in a general view. Association by results of optimization can be rather simply formalized.

For example $n = 1$, the $\tau = 0$ in (1) can be seen that the increase T in m times as will displace high-frequency part of the amplitude-frequency characteristic of object, as reduction k in m times. Therefore it is possible all area of admissible values T and k to break on values of product $G = Tk$ into desirable quantity of intervals best of all equal in logarithmic scale. For example if G_1 - the minimum value of this product and G_4 - the maximum value, it is supposed splitting into three intervals, it is expedient to choose two internal boundary values of an interval G_2 и G_3 next ratio

$$G_2 / G_1 = G_3 / G_2 = G_4 / G_3 \quad (7)$$

The similar result could be received if the interval of admissible values of coefficients as would be broken into two, as well as an interval of admissible values of time constants. It would give four areas. Having appropriated to areas with the smallest and with the greatest values of each of parameters the corresponding characteristic central values k_1 , k_2 , T_1 and T_2 we would receive four different couples of combinations of values of regulators: $Q_1 = \{k_1, T_1\}$, $Q_2 = \{k_1, T_2\}$, $Q_3 = \{k_2, T_1\}$, $Q_4 =$

$\{k_2, T_2\}$. Further we could find out that regulators for Q_2 and Q_3 are identical.

IV. ILLUSTRATIVE EXAMPLE

We will consider a practical problem of control of a steam well. At various temperatures of steam the order of object changes from 3 to 5 at the same time change T , t and k too. We will allocate three characteristic ranges, corresponding to an object order: $n_1 = 3$, $n_2 = 4$, $n_3 = 5$. Further it is necessary to set models and a method of their identification (reference to one of three groups). After that by results of identification we carry out switching on one of the robust regulators. Robust regulators calculate for the fixed value n . Object parameters in different modes are specified below.

$$W_{O1}(s) = \frac{2,8}{(63,5s+1)(64s+1)(64,5s+1)} \exp\{-s16\} \quad (Q_1)$$

$$W_{O2}(s) = \frac{3,2}{(66,5s+1)(67s+1)(67,5s+1)(67s+1)} \exp\{-s17\} \quad (Q_2)$$

$$W_{O3}(s) = \frac{3,4}{(67,5s+1)(68s+1)(68,5s+1)(67,5s+1)(68,5s+1)} \exp\{-s19\} \quad (Q_3)$$

By optimization we will use the size of admissible overcontrol 5% which is put in criterion of optimality. Optimization is carried out in the VisSim program [8-10]. Cost function is set by ratios:

$$F_c = F_1 + F_2, \quad F_N = \int_0^T [|e_N(t)| + K_\infty F_{ZN}] dt, \quad F_{ZN} = \max\{0, 0.05 - e_N(t)\}$$

In case of optimization on the only option of values of the parameters F_2 is equated to zero. The second composed under integral accepts zero value if overcontrol doesn't exceed 5% and rather great positive value by excess of overcontrol this value. This contribution in this case is rather great that received value F_c received a big increment and result of such control by automatic optimization would be rejected. We use big coefficient K_∞ (for example $K_\infty=1000$) to this purpose.

Results of optimization only the models Q_3 is (we will call the regulator R_3): $k_p = 0.364$, $k_I = 1 \cdot 10^{-3}$, $k_d = 18.71$. Transient in the received system is shown in figure 1.

Joint optimization of the regulator for objects Q_1 and Q_3 gives other regulator (we will call it R_2): $k_p=0.465$, $k_I=1.5 \cdot 10^{-3}$, $k_d = 26.7$. Transient in this system is shown in figure 2.

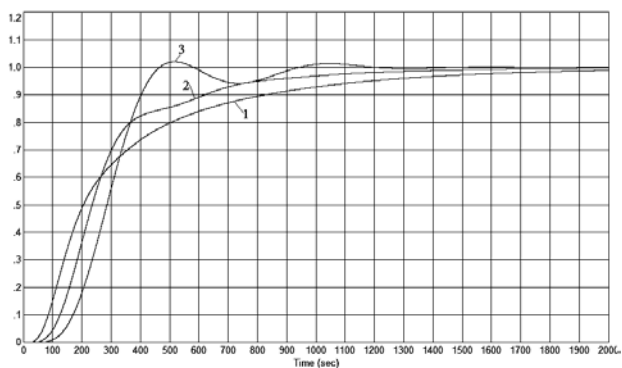

Fig.1 Transient in system with object $Q_1(1)$, $Q_2(2)$, $Q_3(3)$ and regulator R_3

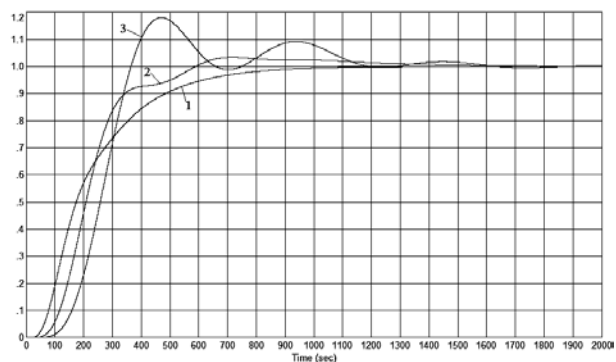

Fig.2 Transient in system with object $Q_1(1)$, $Q_2(2)$, $Q_3(3)$ and regulator R_2

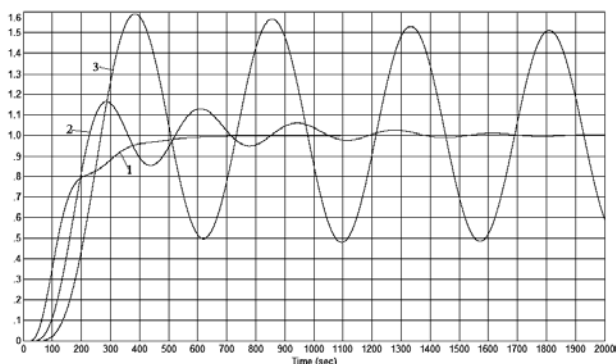

Fig.3 Transient in system with object $Q_1(1)$, $Q_2(2)$, $Q_3(3)$ and regulator R_1

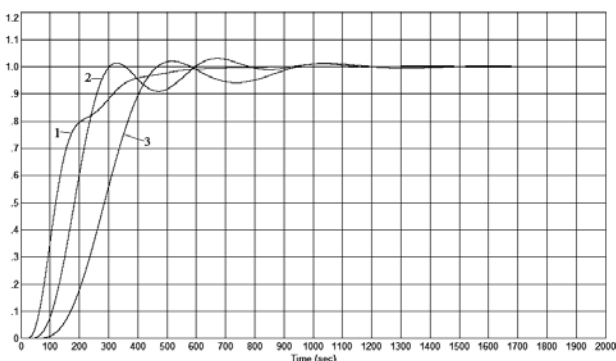

Fig.4 Transient in system with object $Q_1(1)$, $Q_2(2)$, $Q_3(3)$ and regulator R_1 , R_2 , R_3

We see that introduction in criterion of an optimality of integral from a mistake in other system leads to optimization

not separate transient with the fixed object parameters also all set of transients. It isn't obligatory to consider intermediate option Q_2 because apparently from the figure 2 transient for this option has the most attractive appearance therefore a mistake contribution from this option in the general criterion is least essential. It could be expected on the basis of the assumption that if the regulator provides satisfactory transient for extreme options of object parameters that he will provide with a big share of probability acceptable transient for intermediate option of parameters.

We will note that with the new regulator R_2 transient for object with the parameters Q_1 improved in comparison with the regulator R_3 (the mistake decreases quicker) but transient for object with the Q_3 parameters obviously worsened. Really overcontrol instead of 2% began to reach 18% and the mistake decreases much more slowly.

For comparison we will carry out regulator optimization only for object Q_1 . We received the regulator R_1 with following parameters: $k_p = 0.913$, $k_i = 2.3 \cdot 10^{-3}$, $k_d = 40.36$. Transient in this system is shown in figure 3. We see that transient for object with the parameters Q_1 became much more attractive: overcontrol is absent; time of achievement of the ordered value is minimally. However for two other possible combinations of the parameters Q_2 and Q_3 transient became almost unacceptable: overcontrol significantly exceeds 10%, and for Q_3 even reaches 60%.

Thus we can draw a conclusion that though the robust regulator R_2 allows providing acceptable quality for all considered options of object parameters, for two of three options the received system isn't very optimally. If we applied for each combination of object parameters Q_N the optimum regulator R_N then the set of received transients would be more attractive, as shown in figure 4. The set of transients in this case is the most attractive.

V. IDENTIFICATION. BELONGINGS OF OBJECT MODEL TO THE SUBSET

Methods and devices for identification of accessory of the current set of object parameters to a concrete subset can be based on an assessment of the specified parameters or on other principle if it is more effective. At the same time test influences can be used on condition of their sufficient infinitesimal not to break result (accuracy and quality) control of object.

For example value of static coefficient of strengthening k can be defined by giving on object of small step excitation. Definition of an order of object n can be carried out by measurement of transfer function in the field of high frequencies (two or more characteristic frequencies). Definition of value of a time constant of a delay element τ can be carried out by a correlation method. The example of such system is shown in figure 5.

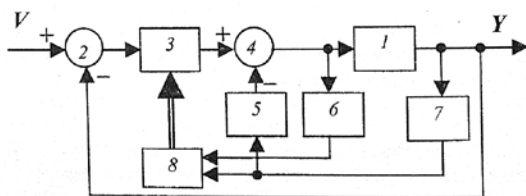

Fig. 5 Offered adaptive system

1 – object; 2,4 – subtracting devices; 3 – the operated regulator; 5 – generator of a test signal; 6,7 – frequency-selective amplitude measuring instruments; 8 – solver

In the device shown in figure 5 frequency-selective amplitude measuring instruments 6 and 7 consist of consistently switched on frequency-selective filters, amplitude detectors and amplitude measuring instruments. It allows to measure amplitudes of signals in the narrow frequency band corresponding to frequency of a signal at the generator of a test signal output 5. The solver 8 calculates the amplitude ratio of the output to the input of object 1 and by result carries its current amplitude-frequency characteristic to one of the allocated subsets. By result of such identification the solver chooses one of precomputed models of the regulator and operates the regulator 3 ordering it to realize this model. Communication from the output of the measuring instrument 7 to the generator 5 isn't obligatory, but can increase operating efficiency of system, providing change of amplitude of the output signal of the generator 5. It allows using optimum value of amplitude of a test signal in each mode. Excessively big amplitude leads to excessive increase of a response to this signal at the object output at the same time insufficient amplitude reduces reliability of measurements. Signal amplitude at the object output in the best way presents sufficiency of this signal for measurements and its sufficient infinitesimally for neglect to it at an assessment of accuracy of working of system.

VI. CONCLUSION

We offered the new method piecewise robust regulators which allows to synthesize the adaptive regulator for control of objects with changing parameters and delay. The method was researched by optimization and modeling that confirmed its efficiency.

ACKNOWLEDGEMENT

The opportunity to discuss the results is possible due to the support of the Russian Foundation of Basic Research (RFBR), and Department of Science & Technology, International Division.

REFERENCES

- [1] V.A. Zhmud, A.N. Zavorin, O.D. Yadryshnikov, "Analysis of a method of design of the robust regulator method of double iterative parallel numerical optimization," *Automatics and Program Engineering*. 2012, № 1, pp. 7-16. (in Russian: Жмудь В.А., Ядрышников О.Д., Заворин А.Н., Полищук А.В. Анализ метода проектирования робастного регулятора методом двойной итеративной параллельной численной оптимизации // Автоматика и программная инженерия.-2012.-№ 1.-С. 7-16.)
- [2] V.A. Zhmud, A.N. Zavorin, V.A. Polishchuk, O.D. Yadryshnikov, "Design of the robust regulators for a power-generating boiler a method of numerical optimization of their parameters for model of ensemble of systems," *Works of a seminar on automatics and the program engineering, devoted to anniversary of the public corporation "NIPS"*. 2012. pp. 141-146. (in Russian: Заворин А.Н., Жмудь В.А., Полищук А.В., Ядрышников О.Д. Проектирование робастных регуляторов для энергетического котла методом численной оптимизации их параметров для модели ансамбля систем. Труды семинара по автоматике и программной инженерии, посвященного Юбилею ОАО «НИПС». 2012. – С. 141-146.)
- [3] K.A. Pupkov, N.D. Egupov, "Methods of the classic and modern theory of automation control," Vol. 5. Moscow. 2004. (in Russian: Методы классической и современной теории автоматического управления: учебник в 5 т. / Под ред. К.А. Пупкова, Н.Д. Егупова. – М.: Изд-во МГТУ им. Н.Э. Баумана, 2004. – Т. 5.-Методы современной теории автоматического управления.)
- [4] J.C. Doyle, K. Glover, P.P. Khargonekar, B.A. Francis, "State-space solutions to standart H2 and H ∞ control problems" // *IEEE Transactions on Automatic Control* AC-34. – № 8. – 1989.
- [5] V.A. Zhmud, A.N. Zavorin, V.A. Polishchuk, O.D. Yadryshnikov, "Design the robust regulators for control of thermal processes of a steam well of a method of numerical optimization of their parameters for model of ensemble of systems" // *Herald of computer and information technologies*. 2013 № 2. С. 47-54. (in Russian: Проектирование робастных регуляторов для управления тепловыми процессами паронагревателя методом численной оптимизации их параметров для модели ансамбля систем. / В.А. Жмудь, А.Н. Заворин, А.В. Полищук, О.Д. Ядрышников // Вестник компьютерных и информационных технологий. 2013 № 2. С. 47-54.)
- [6] A.N. Zavorin, V.A. Polishchuk, O.D. Yadryshnikov, "SYNTHESIS OF BEING SELF-ADJUSTED CONTROL SYSTEMS" // *Collection of scientific works SWorld of the international scientific and practical conference "Modern Directions of Theoretical and Applied Researches 2012" Ukrain, Odessa, 20-31 March, vol. 4. pp. 69-79* (in Russian: Заворин А.Н., Ядрышников О.Д. СИНТЕЗ САМОНАСТРАИВАЮЩИХСЯ СИСТЕМ УПРАВЛЕНИЯ // Сборник научных трудов SWorld международной научно-практической конференции «Современные направления теоретических и прикладных исследований 2012». Украина, Одесса, 20-31 марта 2012. Том 4, стр. 69-79.)
- [7] V.A. Zhmud, A.N. Zavorin, V.A. Polishchuk, O.D. Yadryshnikov, "Method of design of adaptive systems for control of non-stationary objects with delay" // *Scientific herald of NSTU. - 2012. - №4.* (in Russian: Метод проектирования адаптивных систем для управления нестационарными объектами с запаздыванием. / В. А. Жмудь, А. Н. Заворин, А. В. Полищук, О. Д. Ядрышников // Научный вестник НГТУ. - 2012. - №4.)
- [8] V.A. Zhmud, O.D. Yadryshnikov, A.N. Zavorin, "The study of the influence of high-frequency part of logarithmic frequency response curve to the quality of the feedback controls system" // *Proceedings of DST-RFBR-Sponsored Second Indo-Russian Joint Workshop on Computational Intelligence and Modern Heuristics in Automation and Robotics. NSTU, Novosibirsk, Russia. 9th – 12th September 2011. Новосибирск, НГТУ. pp. 97–101.*
- [9] V. Zhmud, O. Yadryshnikov, A. Zavorin, E. Prokhorenko, R.V. Rao, "The Improvement Of The Qualitative Characteristics Of Control Systems With Feedback At Use PI2D2-Regulator" // *Proceedings of the Fifth International Conference on Advances in Mechanical Engineering (ICAME-2011), June 06-08, 2011. Surat – 395 007, Gujarat, India. pp. 280-287.*
- [10] V.A. Zhmud, A.A. Voevoda, A.N. Zavorin, O.D. Yadryshnikov, "The comparative analysis of methods of optimization of regulators with use of software of VisSim and MATLAB" // *Mechatronics, automation, control. № 9. 2012. pp. 37–43.* (in Russian: Сравнительный анализ методов оптимизации регуляторов с использованием программных средств VisSim и MATLAB / В. А. Жмудь, А. А. Воевода, А. Н. Заворин, О. Д. Ядрышников // Мехатроника, автоматизация, управление. № 9. 2012. С. 37–43.)

Applying the Semantic Analyses of Russian Language in the Computer Sign Language Interpretation System

Yuliya S. Manueva*

*Novosibirsk State Technical University, Novosibirsk, Russia

Abstract—Modern society often does not pay enough attention to the problems of the deaf people. As a result of this, people with hearing impairments cannot get a job and have physical, social, psychological difficulties. That is why the communication problem between deaf people claims serious attention. The main translating problems are the problems of homonyms. To solve these problems it was proposed semantic dictionary developed by V.Tuzov, developed software module to execute semantic analysis. The result of module working is correspondence “word-gesture”.

Keywords— computer translation system, Russian sign language, semantic analysis, semantic dictionary

I. INTRODUCTION

Deaf people are a one of the most socially vulnerable category of citizens. Currently in Russia the problem of communication between the company and deaf people are not fully solved, because there is no system of translation from Russian to Russian sign language and vice versa.

The main problem of this study is to model the meanings of words in the sentences. To achieve this goal it is necessary to reflect the specifics of Russian and Russian sign language. It is necessary to solve the problem of homonyms. Homonyms are words with same spelling and pronunciation but may have different meanings. It is solved the tasks.

- 1) Database development of semantic dictionary.
- 2) Morphological characteristics determination.
- 3) Lexical meaning analysis of word.
- 4) Development and coding semantic analysis mechanism.

The meaning is determined by the use of semantic dictionary developed by Vitaly Tuzov. In Russia this module is developed first time.

II. SEMANTIC ANALYSIS TECHNOLOGY

A. Primary Semantic Analysis

The technology of computer sign language involves the following steps: speech recognition, text analysis and translation of the text to the gestural language, visualization, using sign language avatar - interpreter [1]. Analysis of the Russian text consists of morphological analysis, syntactic analysis and semantic analysis [2].

Semantic module starts to execute after morphological analysis and syntactic analysis finish its work [3]. Input information for the system is a text line, obtained to previous steps of speech recognition service. The process of semantic analysis consists of 2 parts: primary semantic analysis and semantic analysis. As the basis of the first step is taken Russian - English machine translation system Dialing [4]. The purpose of this first work is to find initial form of words, morphological characteristics and semantic relation. The main step solves the problem of homonyms by using semantic dictionary. When every word has only one semantic description the semantic module finds corresponding gesture.

B. Computer Semantics of Russian Language

To achieve the main purpose for each word it is proposed valence structure $\langle A_1, \dots, A_n \rangle$, where A_i - a description of the part. Each token is described by a set of characteristics as described in formula 1:

$$A_i = \{ CN_i, BL_j, SD_k, MD_l, C_m, SP_p \} \quad (1)$$

where CN_i - class number, $i=1 \dots N$; BL_j - basis lexeme; $j=1 \dots M$; SD_k - semantic description; $k=1 \dots P$, MD_l - morphologic description; $l=1 \dots S$, C_m - comment; $m=1 \dots L$; SP_p - part of speech, $p=1 \dots W$.

A description of each class contains the following information:

$$Class_i = \{ Number, ClassName, WordQuantity \} \quad (2)$$

The semantics of the basic concepts defined in the main number of the class to which it belongs, but it may also contain an optional description [1]. In the Table I it is showed Part of classifier.

TABLE I. PART OF CLASSIFIER

Class code	Class name	Word number
\$1^a	Noun	88
\$110	Noun. Abstract notion(AN)	4
\$1100/01	Noun. (AN) - abstract - concrete	2
\$1100/02	Noun. (AN) - definite-indefinite	3
\$1100/03	Noun. (AN) - absolute - relative	3

Class code	Class name	Word number
\$1100/04	Noun. (AN) – ordinary - extraordinary	10

On the base of semantic dictionary database was developed. Fragment of database is present in the Fig2.

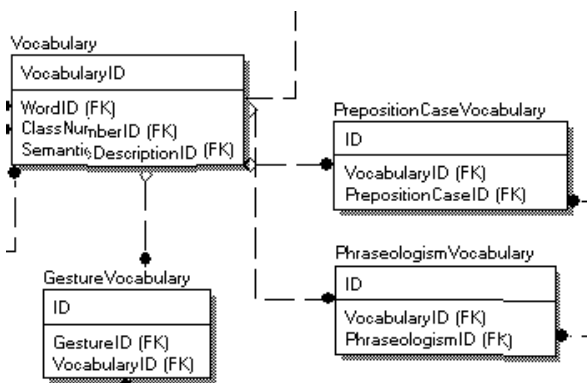

Fig. 1. Database Fragment

III. SEMANTIC ANALYSIS MECHANISM

At the pre-processing stage word by word text processing is made within a single sentence [3]. In the Fig.1 Semantic analysis mechanism is showed.

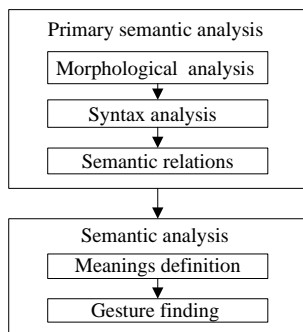

Fig. 2. Semantic Analysis Mechanism

The main objective of this stage is to construct independent alternatives to the words and descriptions of the semantic descriptions and to calculate grammatical type of each alternative, included in the description of the word.

These transformations are carried out in several steps. In the first step primary semantic analyzer provides all the necessary information for the semantic analysis. In the second step determined alternative descriptions for each word. In the third

step, the following auxiliary work: numbered and identified all the alternatives of each word shall be made no semantic class of speech, semantic descriptions of all the arguments submitted.

Built description consists of a set of alternatives, each of which contains two main parts showing morphological information with semantic class words and semantic information. The first part of the alternative contains information about what words this word can be join, the second part - what words it can join. During assembling the interaction always takes place between two standing next to the structure.

Next step of semantic module work is handling of phraseological unit. In semantic dictionary phraseological units are defined in separate alternatives description. To decrease quantity of alternatives it is necessary to find phraseological units and then other description of this word will be deleted. It makes easy next work of semantic module.

Process of preposition analysis contains two parts. At the beginning of this process prepositional phrase is found. Right semantic description of preposition choice depends only on noun in prepositional phrase. Then the module makes analysis the prepositional phrase. Result of this step is right semantic description of preposition.

All the rest of that part of the work semantic analyzer depends on kind of sentence. There are two kind of sentence. First case is sentence with one word, having two and more alternatives. Sentence, which has more than one word, having many alternatives is second type. In the first case there is no cycle and only word with many alternatives is analyzed. All words are broken up into four categories. There are verbs, nouns, adjectives and infinitives. Analyses depend on speech part of word with many alternatives.

In the second case words are analyzed in cycle. Every iteration of cycle begins from check number of words with many alternatives. The sentence is viewed repeatedly left to right and right to left till all words will have only one description. The result of module working is correspondence "word-gesture".

IV. CONCLUSION

Software module to execute semantic analysis was created with use semantic dictionary database. The result of module working is correspondence "word-gesture". For match making "word-gesture" lexical meanings of words were found. Among quantity of word alternatives on base of semantic analyzer one lexical meaning corresponds every word in sentence. For simple preposition semantic analysis algorithms were developed and coded. Current gesture database consists 40% of real quantity of gesture.

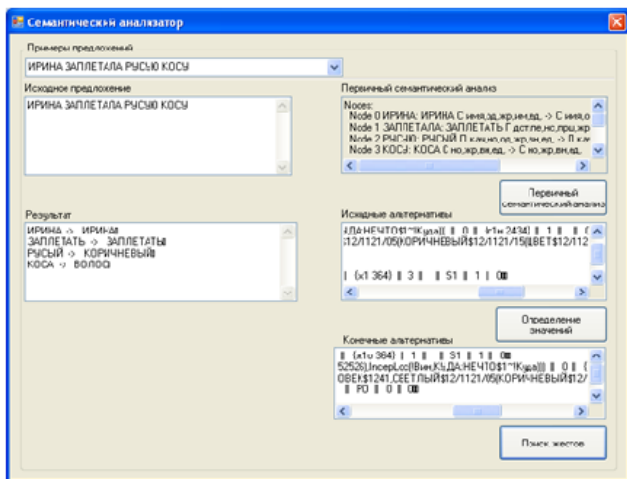

Fig.3. – Semantic Analyses Module

V. FUTURE WORK

In the future it may improve the system. Priority areas include the following modifications:

- Increase the database of gestures;
- Implementation of analyses complex sentences;
- Adding accounting analysis algorithm specifics Russian sign language.

REFERENCES

- [1] Grif Mikhail G. Development of Computer Sign Language Translation Technology for Deaf People / Mikhail G. Grif, Yelena A. Demyanenko, Olga O. Korolkova, Yevgeny B. Tsoy // Proc. of The 6th International Forum of Strategic Technology (IFOST 2011), Harbin University of Science and Technology. August 22-24 2011. – Harbin, China. – P. 674-677.
- [2] Liwei Zhao, Karin Kipper A Machine Translation System from English to American Sign language, Conference of the Association for Machine Translation in the Americas, 2000, pp. 54-67.
- [3] Matt Huenerfauth. Spatial, Temporal, and Semantic Models for American Sign Language Generation: Implications for Gesture Generation, International Journal of Semantic Computing. Volume 2, Number 1 2008.
- [4] A. Socirco Semantic Dictionary in the Automatic Text Processing, pp.88 (in Russian). Сокирко А. Семантические словари в автоматической обработке текста (по материалам системы ДИАЛИНГ) [Текст]: диссертация –88 с.
- [5] V. Tuzov. Computer Semantics of Russian Language, Saint Petersburg, 2003, pp. 391 (in Russian). Тузов В.А. Компьютерная семантика русского языка [Текст]: учебное пособие – СПб: СПбГУ, 2003. – 391с.

Localization methods for a mobile robot

Zhanna Pershina

The department of the systems of collecting and data processing
Novosibirsk state technical university
Novosibirsk, Russia
pershina@tiger.cs.nstu.ru

Iurii Sagitov

The department of information protection collection system
Novosibirsk state technical university
Novosibirsk, Russia
srw.ko10ok@gmail.com

Abstract—The local navigation system of the mobile robot (MR) basing on the current data coming from internal sensors and navigation information collected beforehand, is to provide the most accurate MR localization. That is why in the work the essential methods of coordinate position estimation while MR moving.

Keywords—mobile robot; local navigation; odometry; visual odometry.

I. INTRODUCTION

The following components are included in the local navigation system: sensors, onboard controller, transmission channel, operation desk.

The basic set of sensors while solving navigation target is determined by environmental conditions of MR functioning. The analysis of solving problem of localization showed that encoders, inertial systems, GPS and finders are widely used nowadays. However the listed devices usage has some disadvantages. The navigation with the help of encoders (wheel odometry) is quite problematic while moving on cross-country terrain when wheel slip takes place. The information received from inertial devices changes constantly and needs periodical correction. GPS navigation is not accurate, it needs additional equipment installing and can not be applied in extreme work conditions. The system on the base of finders is very sophisticated. It needs advance knowledge about the environment to compare the distance to the same object at different moments of time. To compensate navigation sensors drawbacks while creating MR functioning inside premises the complex usage of the sensors which needs integration methods developing and sensors data interpreting is proposed.

II. LOCALIZATION METHODS

A. Odometry

Odometry is the most common method of MR localisation. The principle of the method is in the use of encoders, sensors converting the rotary traverse into electrical signals. On the data from encoders the distance made by MR and the rotary traverse can be estimated. On the fig.1 geometrical meaning of the odometry is presented. Given robot position x, y , theta and wheel base width W the new position is to be calculated.

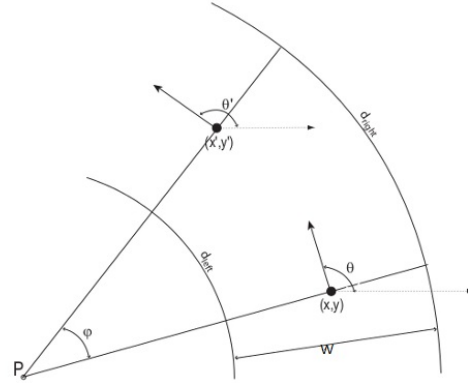

Fig. 1. Odometry geometry

Knowing the wheel diameter and using data from encoders the distance made by this wheel can be calculated by formula (1):

$$L = \pi \cdot D \cdot \frac{n}{N} \quad (1)$$

Where L is overall distance made during given periods of time, n is total number of encoder reports (for the given period of time), N is number of encoder reports during one turn of the wheel, D is wheel diameter. To realize mobile platform with two independent engines the following calculations can be used to estimate its position.

$$C(t_i) = C(t_0) + \frac{D_r + D_l}{W} \quad (2)$$

$$D(t_0, t_1) = \frac{D_r + D_l}{2} \quad (3)$$

Where $C(t)$ is the robot position at the moment t , D_r is the distance, made by right wheel, D_l by left wheel, W is the robot width, $D(t_0, t_1)$ is the distance made during a period of time $[t_0, t_1]$. [2]

So curvilinear trajectory can be approximated to the linear parts where given formulae (2) and (3) are true. Also using the distance made by the platform the Descartes coordinates can be calculated.

$$X(t_1) = X(t_0) + D(t_0, t_1) \cdot \cos C(t_1) \quad (4)$$

$$Y(t_1) = Y(t_0) + D(t_0, t_1) \cdot \sin C(t_1) \quad (5)$$

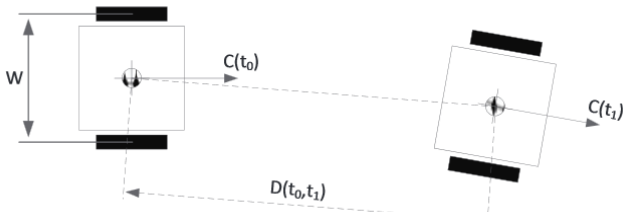

Fig. 2. Estimation of the mobile robot moving

Odometry provides good accuracy on the short distances and high discretization frequency and does not have very high introduction cost. The main disadvantage of the method is the unlimited growth of the uncertainty of position and orientation in time which is caused by the error of wheel measuring and low accuracy grade of the encoders, which over time tends to accumulate.

B. Visual odometry

The visual odometry is a process of receiving odometrical information comparing the sequence of shots from the camera of MR.

Fig.3 the geometrical model of the task to determine the distance from the camera to the obstruction is presented.

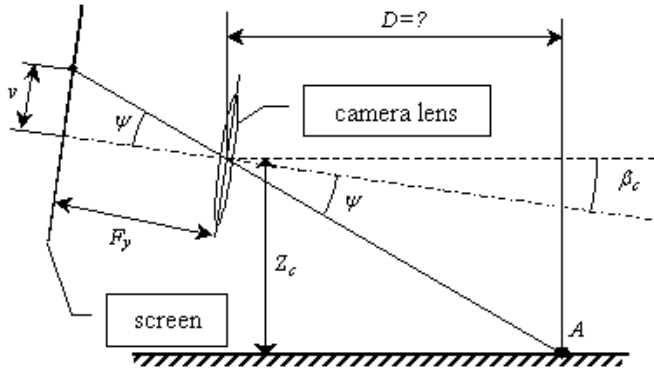

Fig. 3. Estimate of the distance to the obstacle

Variable F_y is the coefficient of proportionality between real and screen coordinates.

$$F_y = \frac{\frac{H}{2}}{\operatorname{tg}\left(\frac{FOV_y}{2}\right)} \quad (6)$$

Where H is the height of the screen in pixels, FOV_y is the viewing angle by height: canting angle of the camera. Z_c is the height of camera installation, V the distance in pixels on the axis Y from the screen center to the point in question.

$$v = \frac{H}{2} - y \quad (7)$$

$$\psi = \arctg\left(\frac{v}{F_y}\right) \quad (8)$$

The required distance D from the camera to the point A:

$$D = \frac{Z_c}{\operatorname{tg}(\psi + \beta_c)} \quad (9)$$

With found distance D real coordinates X and Y of the point can be calculated. The required coordinate X_a of the point A in frame of axes of the camera on the basis of similarity of triangles (Fig.4, a) will be calculated by the formula (10).

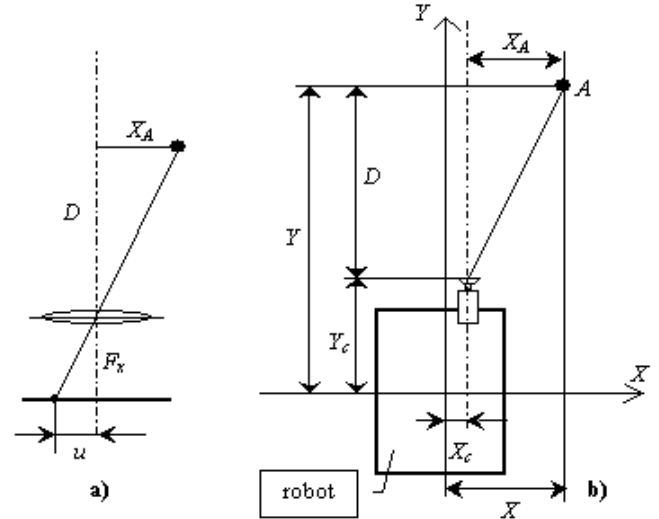

Fig. 4. The estimation of the point coordinates on the basis of known distance: a) coordinate X determining in the frame of axes of the camera, b) transferring the point coordinates from the frame of axes of the camera into the frame of axes of the robot

$$X_a = \frac{u}{F_x} \cdot D \quad (10)$$

Where u is the distance in pixels on the axis X from the screen center to the point in question, W is the screen width, F_x is the proportionality coefficient between real and screen coordinates.

$$u = x - \frac{W}{2} \quad (11)$$

$$F_x = \frac{\frac{W}{2}}{\operatorname{tg}\left(\frac{FOV_x}{2}\right)} \quad (12)$$

Where FOV_x is the camera viewing angle on the level.

$$X = X_a + X_c \quad (13)$$

$$Y = D + Y_c \quad (14)$$

X_c and Y_c is the camera translocation from the robot center on the axis X and Y correspondingly [1].

III. RESULTS OF EXPERIMENTS

To evaluate experimentally the programme realizing the algorithm of visual odometry the robotic engineering system was used StarterKit 2.0 with differential wheel drive which physical form is presented on the fig.5 It was used the camera IP D-Link 930 L. The camera is cramped at the angle 15 relating to the floor.

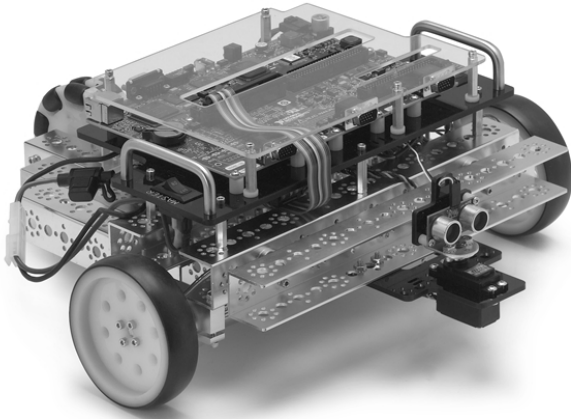

Fig. 5. The robotic platform StarterKit 2.0

Table 1. The properties of the robotic engineering platform StarterKit 2.0

Property	Description	Variable
Wheel diameter	D	100 mm
Distance between drive wheels	d	360 mm
Maximum angular rate	ω	15 rad/s

Table 2 Properties of IP camera D-Link 930 L

Property	Description	Variable
Focus	F	3.15 mm
Viewing angle by width	FOV _x	45.3°
Viewing angle by height	FOV _y	34.5°

To estimate the method accuracy the same set of images received while robot moving ahead on the equal distances. was processed several times While processing root-mean-square deviation of the found trajectory was estimated.

$$c = \frac{\sqrt{\sum_{i=0}^N (Z_i - Z')^2}}{N \cdot L} \cdot 100\% \quad (14)$$

Where Z_i is the found distance per one model displacement; Z' is factual distance per one displacement; N is the shot number, L is the factual travel length

The experiment results show that the visual odometry method allows to measure the path made with error 2.31 %.

During the experiment the following problems were solved: the structure of the visual odometry system was developed, the algorithm of the visual odometry as a programm was relised.

REFERENCES

- [1] D.V. Yevstigneev, "Software for management systems of autonomous mobile robots", 2003, 218 (rus)
- [2] E.A. Devyaterikov, B.B. Mikhailov, "Mobile robot movement control system with visual odometer", Ekstremalnaya robototekhnika, 2013: Sb. Trudov NTK. – St.-Petersburg, 2013, pp. 103–108 (rus)
- [3] E. Papadopoulos, M. Misailidis. "On Differential Drive Robot Odometry with Application to Path Planning," Proceedings of the European ControlConference, 2007, pp. 5492-5499.

Chemnitzer Informatik-Berichte

In der Reihe der Chemnitzer Informatik-Berichte sind folgende Berichte erschienen:

- CSR-08-01** Johannes Steinmüller, Holger Langner, Marc Ritter, Jens Zeidler (Hrsg.), 15 Jahre Künstliche Intelligenz an der TU Chemnitz, April 2008, Chemnitz
- CSR-08-02** Petr Kroha, José Emilio Labra Gayo, Using Semantic Web Technology in Requirements Specifications, November 2008, Chemnitz
- CSR-09-01** Amin Coja-Oghlan, Andreas Goerdts, André Lanka, Spectral Partitioning of Random Graphs with Given Expected Degrees - Detailed Version, Januar 2009, Chemnitz
- CSR-09-02** Enrico Kienel, Guido Brunnett, GPU-Accelerated Contour Extraction on Large Images Using Snakes, Februar 2009, Chemnitz
- CSR-09-03** Peter Köchel, Simulation Optimisation: Approaches, Examples, and Experiences, März 2009, Chemnitz
- CSR-09-04** Maximilian Eibl, Jens Kürsten, Marc Ritter (Hrsg.), Workshop Audiovisuelle Medien: WAM 2009, Juni 2009, Chemnitz
- CSR-09-05** Christian Hörr, Elisabeth Lindinger, Guido Brunnett, Considerations on Technical Sketch Generation from 3D Scanned Cultural Heritage, September 2009, Chemnitz
- CSR-09-06** Christian Hörr, Elisabeth Lindinger, Guido Brunnett, New Paradigms for Automated Classification of Pottery, September 2009, Chemnitz
- CSR-10-01** Maximilian Eibl, Jens Kürsten, Robert Knauf, Marc Ritter, Workshop Audiovisuelle Medien, Mai 2010, Chemnitz
- CSR-10-02** Thomas Reichel, Gudula Rüniger, Daniel Steger, Haibin Xu, IT-Unterstützung zur energiesensitiven Produktentwicklung, Juli 2010, Chemnitz
- CSR-10-03** Björn Krellner, Thomas Reichel, Gudula Rüniger, Marvin Ferber, Sascha Hunold, Thomas Rauber, Jürgen Berndt, Ingo Nobbers, Transformation monolithischer Business-Softwaresysteme in verteilte, workflowbasierte Client-Server-Architekturen, Juli 2010, Chemnitz
- CSR-10-04** Björn Krellner, Gudula Rüniger, Daniel Steger, Anforderungen an ein Datenmodell für energiesensitive Prozessketten von Powertrain-Komponenten, Juli 2010, Chemnitz
- CSR-11-01** David Brunner, Guido Brunnett, Closing feature regions, März 2011, Chemnitz

Chemnitzer Informatik-Berichte

- CSR-11-02** Tom Kühnert, David Brunner, Guido Brunnett, Betrachtungen zur Skelettextraktion umformtechnischer Bauteile, März 2011, Chemnitz
- CSR-11-03** Uranchimeg Tudevtagva, Wolfram Hardt, A new evaluation model for eLearning programs, Dezember 2011, Chemnitz
- CSR-12-01** Studentensymposium Informatik Chemnitz 2012, Tagungsband zum 1. Studentensymposium Chemnitz vom 4. Juli 2012, Juni 2012, Chemnitz
- CSR-12-02** Tom Kühnert, Stephan Rusdorf, Guido Brunnett, Technischer Bericht zum virtuellen 3D-Stiefeldesign, Juli 2012, Chemnitz
- CSR-12-03** René Bergelt, Matthias Vodel, Wolfram Hardt, Generische Datenerfassung und Aufbereitung im Kontext verteilter, heterogener Sensor-Aktor-Systeme, August 2012, Chemnitz
- CSR-12-04** Arne Berger, Maximilian Eibl, Stephan Heinich, Robert Knauf, Jens Kürsten, Albrecht Kurze, Markus Rickert, Marc Ritter, Schlussbericht zum InnoProfile Forschungsvorhaben sachsMedia - Cooperative Producing, Storage, Retrieval and Distribution of Audiovisual Media (FKZ: 03IP608), September 2012, Chemnitz
- CSR-12-05** Anke Tallig, Grenzgänger - Roboter als Mittler zwischen der virtuellen und realen sozialen Welt, Oktober 2012, Chemnitz
- CSR-13-01** Navchaa Tserendorj, Uranchimeg Tudevtagva, Ariane Heller, Grenzgänger - Integration of Learning Management System into University-level Teaching and Learning, Januar 2013, Chemnitz
- CSR-13-02** Thomas Reichel, Gudula Rüniger, Multi-Criteria Decision Support for Manufacturing Process Chains, März 2013, Chemnitz
- CSR-13-03** Haibin Xu, Thomas Reichel, Gudula Rüniger, Michael Schwind, Softwaretechnische Verknüpfung der interaktiven Softwareplattform Energy Navigator und der Virtual Reality Control Platform, Juli 2013, Chemnitz
- CSR-13-04** International Summerworkshop Computer Science 2013, Proceedings of International Summerworkshop 17.7. - 19.7.2013, Juli 2013, Chemnitz
- CSR-13-05** Jens Lang, Gudula Rüniger, Paul Stöcker, Dynamische Simulationskopplung von Simulink-Modellen durch einen Functional-Mock-up-Interface- Exportfilter, August 2013, Chemnitz
- CSR-14-01** International Summerschool Computer Science 2014, Proceedings of Summerschool 7.7.-13.7.2014, Juni 2014, Chemnitz

Chemnitzer Informatik-Berichte

ISSN 0947-5125

Herausgeber: Fakultät für Informatik, TU Chemnitz
Straße der Nationen 62, D-09111 Chemnitz